



Electrical connection systems

Copper tubular cable lugs and connectors	10	Aluminium/copper compression cable lugs and connectors	106
Tubular cable lugs	10	Aluminium/copper compression cable lugs	108
Tubular cable lugs for switchgear connections	16	Aluminium/copper compression joints	111
Angle tubular cable lugs	17	Bi-metallic washer	114
Connectors	21	Tool application chart	115
Insulated tubular cable lugs und connectors	25		
Tubular cable lugs and connectors, blue connection®	28	Clamps and screw connectors	116
Tubular cable lugs and compression joints for solid conductors	30	Punched cable lugs - copper	118
Tubular cable lugs and connectors for fine stranded conductors	33	Screw connectors with soldering hole - brass	119
Tool application chart	38	Parallel groove clamps - copper	120
		C- and H-shaped clamps - copper	122
		Screw connector for shielded copper wires	124
Tubular cable lugs and connectors - nickel, stainless steel	46	Screw connectors for street lighting - brass	124
Tubular cable lugs and connectors - stainless steel	48	Screw connectors, high-resistant aluminium alloy	125
Tubular cable lugs and connectors - nickel	50	Compact tab connectors, high resistant aluminium alloy	130
Tool application chart	53	Tool application chart	133
Copper compression cable lugs and connectors acc. to DIN	54	Cable end-sleeves	136
Compression cable lugs acc. to DIN 46235	56	Cable end-sleeves DIN 46228, part 1 and part 2	138
Angle compression cable lugs	58	Insulated cable-end sleeves acc. to DIN 46228, part 4 and similar versions	141
Compression cable lugs, special type	62	Insulated cable end-sleeves for short circuit resistant conductors	146
Compression joints acc. to DIN 46267, part 1 and similar versions	64	Insulated twin cable-end sleeves	147
Tool application chart	69	Insulated cable-end sleeves, strips and tapes	148
		Tool application chart	150
Copper terminals, connectors and pin terminals acc. to DIN	72	Cable connections, insulated and non insulated	154
Solderless terminals acc. to DIN 46234	74	Insulated terminals	156
Insulated solderless terminals	76	Non insulated flat connectors	167
Solderless terminals, fork and pin type	78	Flexible connectors	172
Insulated solderless terminals for meter connections	80	Tool application chart	175
Solderless connectors acc. to DIN 46341, part 1	80		
Tool application chart	82	Assortments	178
		Pocket boxes with cable end-sleeves	180
Sleeves for compacted conductors and sector-shaped conductors - copper	86	Pocket boxes with insulated cable end-sleeves	180
		Assortment boxes with cable end-sleeves	185
Aluminium compression cable lugs and connectors acc. to DIN	92	Assortment boxes with insulated cable-end sleeves	186
Aluminium compression cable lugs acc. to DIN 46329 and similar versions	94	Assortment boxes with tubular and compression cable lugs	189
Aluminium compression joints acc. to DIN 46267 part 2 and similar versions	97	Assortment boxes with insulated terminals	190
Aluminium reduction compression joints	99	Steel carrying cases / bags	192
Aluminium compression joints, full tension	101		
Aluminium compression cable lugs and connectors for Al/St cables DIN EN 50182	102	L-BOXes	198
Tool application chart	103		



THE CLASSIC - COPPER TUBULAR CABLE LUGS

Not every product becomes a classic at Klauke. Only the best ones. Tubular cable lugs made from high-quality electrolytic copper have been part of the Klauke standard range since 1960. The hallmarks: We handle all phases, from development to production. We monitor each and every step. The result: The certified classic remains - in every version.



In brief

- ▶ **Everything from a single source, from development to production**
- ▶ **Best electrical conductivity thanks to electrolytic copper**
- ▶ **Available for all cross sections and in many special versions**
- ▶ **Tested to international standards**

► **The system - Klauke connectors**

At Klauke all products are matched to one another and we manufacture in our own factories. We think in your work steps – and produce everything systematically. Every cable lug, every tool for the perfect connection.

- Full flexibility through solutions for all conductor classes to DIN EN 60228
- For cables with compacted round conductors, cables with sector-shaped conductors and to suit individual requirements
- A single source - for everything from the cable lug to the tool for professional electrical installations

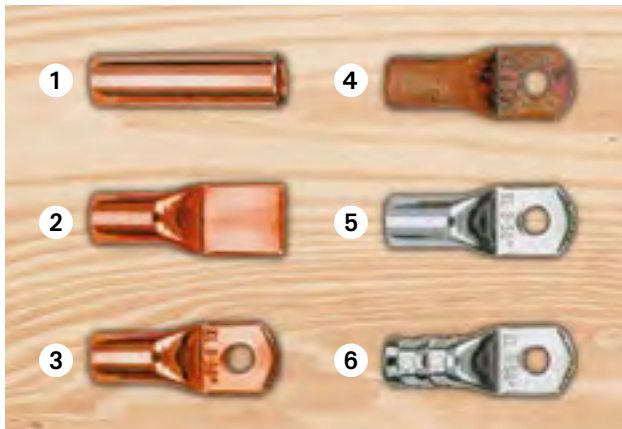

- | | |
|------------------------|----------------------|
| 1 Source material | 4 Annealing |
| 2 Folding and crimping | 5 Tinned end product |
| 3 Punching | 6 After crimping |

► **The preparation - Traditional quality**

The best material is the basis for quality products. For our classics we use - as for all Klauke products - exclusively high-quality material from certified suppliers. You get all our cable lugs with the optimum features. To achieve this, we manufacture using a special annealing process.

- Optimum conductivity, high loading capacity and increased safety thanks to high-quality materials
- Outstanding processing properties

► **The proof - independent quality tests**

Klauke aspires to its own high standard. We have this verified by several independent inspection authorities and have put ourselves through the tough IEC tests - with success.

- IEC (International Electric Commission): The IEC is an advisory board for standards in the electrical engineering and electronics sector. The certifications encompass all areas of electrical engineering that have to meet especially high demands.
- UL (Underwriters Laboratories): UL is an independent organisation that examines and certifies products for safety. The certification is particularly important on the American market.

- DNV (Det Norske Veritas) and GL (Germanischer Lloyd): DNV and GL have now merged to form the world's largest consulting company for onshore and offshore systems.





Tubular cable lugs, Cu, standard type

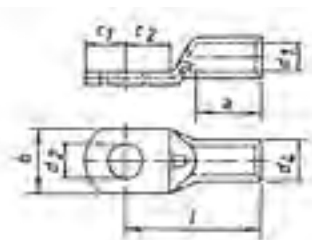

- ▶ Cable lug for fine-stranded round conductors, e.g. to DIN EN 60228 Cl. 5
- ▶ Simple processing thanks to inspection hole for monitoring full conductor insertion



Characteristics

- Annealed material optimises material and crimping properties
- Simple and safe connection due to flat contact surfaces and internal chamfer
- Item identification on cable lug



Material

- Copper (EN13600)



Surface

- Tin-plated to protect against corrosion

Technical instructions

- Tool: see page 38

Nominal cross section mm ²	Size of bolt dia.	Part No.	Dimension mm								Weight/100 pcs. ~ kg	Packing unit/pcs
			d1	a	b	d2	d4	c1	c2	l		
0.75	M3	91R3	1.3	6	6.0	3.2	2.8	3.25	4.0	12	0.060	100
	M4	91R4	1.3	6	6.5	4.3	2.8	4.00	5.0	13	0.060	100
	M5	91R5	1.3	6	7.5	5.3	2.8	4.75	5.5	14	0.060	100
1.5	M3	92R3	1.8	6	6.5	3.2	3.3	3.25	4.0	12	0.080	100
	M4	92R4	1.8	6	6.5	4.3	3.3	4.00	5.0	13	0.080	100
	M5	92R5	1.8	6	7.5	5.3	3.3	4.75	5.5	14	0.080	100
	M6	92R6	1.8	6	9.0	6.5	3.3	6.50	6.5	16	0.090	100
2.5	M3	93R3	2.3	6	7.5	3.2	4.2	3.25	4.0	12	0.120	100
	M4	93R4	2.3	6	7.5	4.3	4.2	4.00	5.0	13	0.120	100
	M5	93R5	2.3	6	8.5	5.3	4.2	4.75	5.5	14	0.130	100
	M6	93R6	2.3	6	9.5	6.5	4.2	6.50	6.5	16	0.150	100
	M8	93R8	2.3	6	13.0	8.5	4.2	7.75	9.5	20	0.180	100
4	M4	94R4	3.0	8	8.5	4.3	5.0	4.75	5.5	18	0.210	100
	M5	94R5	3.0	8	9.0	5.3	5.0	4.75	6.0	18	0.213	100
	M6	94R6	3.0	8	10.0	6.5	5.0	6.50	6.5	19	0.220	100
	M8	94R8	3.0	8	13.0	8.5	5.0	8.50	9.5	22	0.280	100
6	M4	95R4	4.0	9	9.5	4.3	6.0	5.00	5.5	18	0.290	100
	M5	95R5	4.0	9	9.5	5.3	6.0	6.00	6.0	19	0.300	100
	M6	95R6	4.0	9	10.0	6.5	6.0	7.00	6.5	19	0.300	100
	M8	95R8	4.0	9	14.0	8.5	6.0	8.50	9.5	22	0.320	100



Tubular cable lugs, Cu, fork type

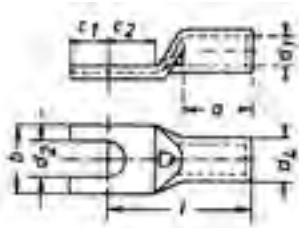

- ▶ Cable lug to 6 mm² for fine-stranded round conductors, 10 mm² and 16 mm² for multi-stranded round conductors to DIN EN 60228
- ▶ Simple fork-type mounting
- ▶ Simple processing thanks to inspection hole to check the inserted conductor

Characteristics

- Annealed material optimises material and crimping properties
- Simple and safe connection due to flat contact surfaces and internal chamfer
- Item identification on cable lug

Material

- Copper (EN13600)

Surface

- Tin-plated to protect against corrosion

Technical instructions

- Tool: see page 38

Nominal cross section mm ²	Size of bolt dia.	Part No.	Dimension mm								Weight/ 100 pcs. ~ kg	Packing unit/pcs
			d1	a	b	d2	d4	c1	c2	l		
0.75	M3	91C3	1.3	6	6.0	3.2	2.8	3.25	4.0	12	0.06	100
	M4	91C4	1.3	6	6.5	4.3	2.8	4.00	5.0	13	0.05	100
	M5	91C5	1.3	6	7.5	5.3	2.8	4.75	5.5	14	0.06	100
1.5	M3	92C3	1.8	6	6.5	3.2	3.3	3.25	4.0	12	0.07	100
	M4	92C4	1.8	6	6.5	4.3	3.3	4.00	5.0	13	0.07	100
	M5	92C5	1.8	6	7.5	5.3	3.3	4.75	5.5	14	0.07	100
	M6	92C6	1.8	6	9.0	6.5	3.3	6.50	6.5	16	0.08	100
2.5	M3	93C3	2.3	6	7.5	3.2	4.2	3.25	4.0	12	0.12	100
	M4	93C4	2.3	6	7.5	4.3	4.2	4.00	5.0	13	0.11	100
	M5	93C5	2.3	6	8.5	5.3	4.2	4.75	5.5	14	0.12	100
4	M6	93C6	2.3	6	9.5	6.5	4.2	6.50	6.5	16	0.10	100
	M4	94C4	3.0	8	8.5	4.3	5.0	4.75	5.5	17	0.19	100
	M5	94C5	3.0	8	9.0	5.3	5.0	4.75	6.0	17	0.19	100
	M6	94C6	3.0	8	10.0	6.5	5.0	6.50	6.5	19	0.21	100
6	M8	94C8	3.0	8	13.0	8.5	5.0	8.50	9.5	22	0.24	100
	M4	95C4	4.0	9	9.5	4.3	6.0	5.00	5.5	18	0.27	100
	M5	95C5	4.0	9	9.5	5.3	6.0	6.00	6.0	19	0.32	100
	M6	95C6	4.0	9	10.0	6.5	6.0	7.00	6.5	19	0.27	100
10	M8	95C8	4.0	9	14.0	8.5	6.0	8.50	9.0	22	0.31	100
	M5	96C5	4.5	10	12.0	5.5	7.0	6.50	7.5	22	0.45	100
	M6	96C6	4.5	10	12.0	6.5	7.0	6.50	7.5	22	0.41	100
	M8	96C8	4.5	10	15.0	8.5	7.0	10.00	10.0	25	0.52	100
16	M5	97C5	5.5	13	12.0	5.5	8.5	5.50	6.5	26	0.81	100
	M6	97C6	5.5	13	12.0	6.5	8.5	6.25	7.5	27	0.81	100
	M8	97C8	5.5	13	15.0	8.5	8.5	8.50	9.5	29	0.90	100



Tubular cable lugs, Cu, standard type

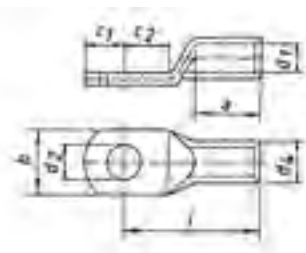

- ▶ For multi-stranded round conductors, e.g. to DIN EN 60228 Cl. 2
- ▶ For pre-rounded multi-stranded sector shaped conductors
- ▶ Ideal cable lug for control cabinet construction
- ▶ In combination with EKM 60 ID suitable for fine-stranded conductors

Characteristics

- Annealed material optimises material and crimping properties
- To DIN EN 61373 class 1B vibration-tested
- Simple and safe connection due to flat contact surfaces and internal chamfer
- Item identification on cable lug

Material

- Copper (EN13600)



Surface

- Tin-plated to protect against corrosion



Technical instructions

- Tool: see page 38
- Sleeves for compacted conductors and sleeves for 3-core and 4-core cables, see chapter „Sleeves for compacted conductors and sector shaped conductors - Cu“



Additional information

- Also available as featured article with inspection hole, part number appendix „MS“



Nominal cross section mm ²	Size of bolt dia.	Part No.	Dimension mm								Weight/ 100 pcs. ~ kg	Packing unit/pcs
			d1	a	b	d2	d4	c1	c2	l		
6	M5	1R5	3.5	9	10	5.5	6.5	6.50	7.5	21	0.50	100
	M6	1R6	3.5	9	12	6.5	6.5	6.50	7.5	21	0.47	100
	M8	1R8	3.5	9	15	8.5	6.5	10.00	10.0	23	0.54	100
	M10	1R10	3.5	9	17	10.5	6.5	12.00	12.0	25	0.59	100
	M12	1R12	3.5	9	19	13.0	6.5	13.00	13.0	28	0.63	100
10	M5	2R5	4.5	10	12	5.5	7.0	6.50	7.5	22	0.50	100
	M6	2R6	4.5	10	12	6.5	7.0	6.50	7.5	22	0.49	100
	M8	2R8	4.5	10	15	8.5	7.0	10.00	10.0	25	0.58	100
	M10	2R10	4.5	10	17	10.5	7.0	12.00	12.0	27	0.62	100
	M12	2R12	4.5	10	19	13.0	7.0	13.00	13.0	29	0.64	100
16	M5	3R5	5.5	13	12	5.5	8.5	5.50	6.5	26	0.84	100
	M6	3R6	5.5	13	12	6.5	8.5	6.25	7.5	27	0.86	100
	M8	3R8	5.5	13	15	8.5	8.5	8.50	9.5	29	0.93	100
	M10	3R10	5.5	13	17	10.5	8.5	10.50	11.5	31	0.99	100
	M12	3R12	5.5	13	19	13.0	8.5	12.00	13.0	33	1.02	100
25	M5	4R5	7.0	15	14	5.5	10.0	7.50	7.5	30	1.22	25
	M6	4R6	7.0	15	14	6.5	10.0	7.50	7.5	30	1.20	100
	M8	4R8	7.0	15	16	8.5	10.0	10.00	10.0	32	1.31	100
	M10	4R10	7.0	15	18	10.5	10.0	12.00	12.0	34	1.57	100
	M12	4R12	7.0	15	19	13.0	10.0	13.00	13.0	35	1.39	25
	M14	4R14	7.0	15	21	15.0	10.0	14.50	14.5	38	1.49	25
35	M6	5R6	8.5	17	17	6.5	12.0	7.50	7.5	32	1.85	100
	M8	5R8	8.5	17	17	8.5	12.0	10.00	10.0	34	2.00	100
	M10	5R10	8.5	17	19	10.5	12.0	12.00	12.0	37	2.13	100
	M12	5R12	8.5	17	21	13.0	12.0	13.00	13.0	38	2.12	100
	M14	5R14	8.5	17	21	15.0	12.0	14.50	14.5	40	2.18	25
	M16	5R16	8.5	17	26	17.0	12.0	16.00	16.0	42	2.24	25

See next page



Tubular cable lugs, Cu, standard type

Nominal cross section mm ²	Size of bolt dia.	Part No.	Dimension mm								Weight/100 pcs. ~ kg	Packing unit/pcs
			d1	a	b	d2	d4	c1	c2	l		
50	M6	6R6	10.0	19	20	6.5	14.0	10.00	10.0	37	3.00	25
	M8	6R8	10.0	19	20	8.5	14.0	10.00	10.0	37	2.93	50
	M10	6R10	10.0	19	20	10.5	14.0	12.00	12.0	39	3.08	50
	M12	6R12	10.0	19	23	13.0	14.0	13.00	13.0	43	3.23	50
	M14	6R14	10.0	19	23	15.0	14.0	14.50	14.5	45	3.32	25
	M16	6R16	10.0	19	28	17.0	14.0	16.00	16.0	46	3.38	25
	M20	6R20	10.0	19	30	21.0	14.0	19.00	19.0	48	3.46	25
70	M6	7R6	12.0	21	23	6.5	16.5	10.00	10.0	43	4.49	25
	M8	7R8	12.0	21	23	8.5	16.5	10.00	10.0	43	4.38	50
	M10	7R10	12.0	21	23	10.5	16.5	12.00	12.0	44	4.54	50
	M12	7R12	12.0	21	23	13.0	16.5	13.00	13.0	46	4.63	50
	M14	7R14	12.0	21	23	15.0	16.5	14.50	14.5	48	4.76	25
	M16	7R16	12.0	21	28	17.0	16.5	16.00	16.0	50	4.24	25
	M20	7R20	12.0	21	30	21.0	16.5	19.00	19.0	53	5.09	25
95	M8	8R8	13.5	25	26	8.5	18.0	12.00	12.0	48	5.44	25
	M10	8R10	13.5	25	26	10.5	18.0	12.00	12.0	48	5.40	50
	M12	8R12	13.5	25	26	13.0	18.0	13.00	13.0	49	5.56	50
	M14	8R14	13.5	25	26	15.0	18.0	14.50	14.5	51	5.62	25
	M16	8R16	13.5	25	28	17.0	18.0	16.00	16.0	54	5.82	50
	M20	8R20	13.5	25	36	21.0	18.0	22.00	22.0	60	6.71	25
120	M8	9R8	15.0	26	28	8.5	19.5	14.00	14.0	51	6.72	25
	M10	9R10	15.0	26	28	10.5	19.5	14.00	14.0	51	6.57	50
	M12	9R12	15.0	26	28	13.0	19.5	14.00	14.0	51	6.38	50
	M14	9R14	15.0	26	28	15.0	19.5	15.00	15.0	52	6.45	25
	M16	9R16	15.0	26	30	17.0	19.5	16.00	16.0	54	6.51	50
	M20	9R20	15.0	26	36	21.0	19.5	22.00	22.0	63	7.74	25
150	M8	10R8	16.5	30	31	8.5	21.0	14.00	14.0	56	7.78	10
	M10	10R10	16.5	30	31	10.5	21.0	14.00	14.0	56	7.62	10
	M12	10R12	16.5	30	31	13.0	21.0	15.00	15.0	57	7.73	25
	M14	10R14	16.5	30	31	15.0	21.0	15.00	15.0	57	7.64	10
	M16	10R16	16.5	30	31	17.0	21.0	16.00	16.0	58	7.53	10
	M20	10R20	16.5	30	36	21.0	21.0	22.00	22.0	66	8.80	10
185	M10	11R10	19.0	30	35	10.5	24.0	18.00	18.0	65	11.75	10
	M12	11R12	19.0	30	35	13.0	24.0	18.00	18.0	65	11.82	10
	M14	11R14	19.0	30	35	15.0	24.0	18.00	18.0	65	11.39	10
	M16	11R16	19.0	30	35	17.0	24.0	18.00	18.0	65	11.24	25
	M20	11R20	19.0	30	39	21.0	24.0	22.00	22.0	69	12.00	10
240	M10	12R10	21.0	35	39	10.5	26.0	21.50	19.0	72	14.72	10
	M12	12R12	21.0	35	39	13.0	26.0	21.50	19.0	72	14.55	10
	M14	12R14	21.0	35	39	15.0	26.0	21.50	19.0	72	14.24	10
	M16	12R16	21.0	35	39	17.0	26.0	21.50	19.0	72	14.09	25
	M20	12R20	21.0	35	39	21.0	26.0	21.50	19.0	72	13.60	10
300	M12	13R12	23.5	44	43	13.0	29.5	24.00	24.0	87	23.33	5
	M14	13R14	23.5	44	43	15.0	29.5	24.00	24.0	87	23.14	5
	M16	13R16	23.5	44	43	17.0	29.5	24.00	24.0	87	22.74	5
	M20	13R20	23.5	44	43	21.0	29.5	24.00	24.0	87	22.19	5
400	M12	14R12	27.0	44	49	13.0	34.0	24.00	24.0	90	32.41	5
	M14	14R14	27.0	44	49	15.0	34.0	24.00	24.0	90	32.24	5
	M16	14R16	27.0	44	49	17.0	34.0	24.00	24.0	90	31.98	5
	M20	14R20	27.0	44	49	21.0	34.0	24.00	24.0	90	31.41	5



Tubular cable lugs for switchgear connections, standard type

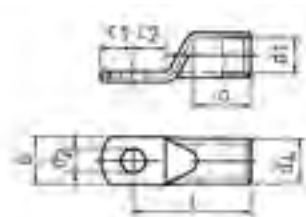

- ▶ For multi-stranded, round conductors e.g. to DIN EN 60228
- ▶ For pre-rounded multi-stranded sector shaped conductors
- ▶ For connecting in switch cabinets with reduced connecting space
- ▶ Narrow palm version manufactured without material loss
- ▶ In combination with EKM 60 ID suitable for fine-stranded conductors

Characteristics

- Annealed material optimises material and crimping properties
- Simple and safe connection due to flat contact surfaces and internal chamfer

Material

- Copper (EN13600)

Surface

- Tin-plated to protect against corrosion

Technical instructions

- Tool: see page 38
- Sleeves for compacted conductors and sleeves for 3-core and 4-core cables, see chapter „Sleeves for compacted conductors and sector shaped conductors - Cu“

Additional information

- Also available as featured article with inspection hole, part number appendix „MS“



Nominal cross section mm ²	Size of bolt dia.	Part No.	Dimension mm								Weight/ 100 pcs. ~ kg	Packing unit/pcs
			d1	a	b	d2	d4	c1	c2	l		
35	M6	5SG6	8.5	17	15.0	6.5	12.0	7.5	7.5	32	1.78	25
		6SG6	10.0	19	15.0	6.5	14.0	10.0	10.0	37	2.95	25
50	M8	6SG8	10.0	19	17.0	8.5	14.0	10.0	10.0	37	2.82	25
	M10	6SG10	10.0	19	19.0	10.5	14.0	11.5	12.0	39	3.08	25
70	M6	7SG6	12.0	21	17.0	6.5	16.5	10.0	10.0	43	4.22	25
	M8	7SG8	12.0	21	17.0	8.5	16.5	10.0	10.0	43	4.10	25
	M10	7SG10	12.0	21	19.0	10.5	16.5	11.5	12.0	44	4.45	25
	M12	7SG12	12.0	21	19.0	13.0	16.5	13.0	13.0	46	4.22	25
95	M6	8SG6	13.5	25	19.0	6.5	18.0	11.5	12.0	48	5.49	25
	M8	8SG8	13.5	25	19.0	8.5	18.0	11.5	12.0	48	5.46	25
	M10	8SG10	13.5	25	19.0	10.5	18.0	11.5	12.0	48	5.13	25
	M12	8SG12	13.5	25	19.0	13.0	18.0	13.0	13.0	49	5.15	25
120	M6	9SG6	15.0	26	19.0	6.5	19.5	11.5	14.0	51	6.16	10
	M8	9SG8	15.0	26	19.0	8.5	19.5	11.5	14.0	51	5.94	10
	M10	9SG10	15.0	26	19.0	10.5	19.5	11.5	14.0	51	5.81	10
	M12	9SG12	15.0	26	19.0	13.0	19.5	14.0	14.0	51	5.92	10
150	M6	10SG6	16.5	30	19.0	6.5	21.0	11.5	14.0	56	6.85	10
	M8	10SG8	16.5	30	19.0	8.5	21.0	11.5	14.0	56	6.80	10
	M10	10SG10	16.5	30	19.0	10.5	21.0	11.5	14.0	56	6.75	10
	M12	10SG12	16.5	30	19.0	13.0	21.0	15.0	15.0	57	7.15	10
185	M10	11SG10	19.0	30	24.5	10.5	24.0	11.5	18.0	65	10.59	10
	M12	11SG12	19.0	30	31.0	13.0	24.0	18.0	18.0	65	11.09	10
240	M16	11SG16	19.0	30	31.0	17.0	24.0	18.0	18.0	65	9.76	10
	M10	12SG10	21.0	35	31.0	10.5	26.0	11.5	19.0	72	12.70	5
	M12	12SG12	21.0	35	31.0	13.0	26.0	21.5	19.0	72	13.72	5
300	M16	12SG16	21.0	35	31.0	17.0	26.0	21.5	19.0	72	13.28	5
	M10	13SG10	23.5	44	31.0	10.5	30.0	11.5	24.0	87	19.70	5
	M12	13SG12	23.5	44	31.0	13.0	30.0	24.0	24.0	87	22.72	5
	M16	13SG16	23.5	44	31.0	17.0	30.0	24.0	24.0	87	22.50	5



Angled tubular cable lugs, Cu, 90° angled, standard type

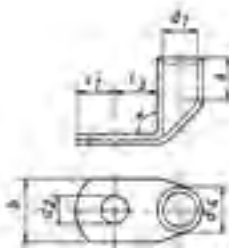

- ▶ For multi-stranded, round conductors e.g. to DIN EN 60228
- ▶ For pre-rounded multi-stranded sector shaped conductors
- ▶ Flat contact surface by special angle pressing technology
- ▶ In combination with the EKM 60 ID suitable for fine stranded conductors

Characteristics

- Annealed material optimises material and crimping properties
- Simple cable entry due to internal chamfer
- Item identification on cable lug

Material

- Copper (EN13600)

Surface

- Tin-plated to protect against corrosion

Technical instructions

- Tool: see page 38
- Sleeves for compacted conductors and sleeves for 3-core and 4-core cables, see chapter „Sleeves for compacted conductors and sector shaped conductors - Cu“

Additional information

- Also available as featured article with inspection hole, part number appendix „MS“

Nominal cross section mm ²	Size of bolt dia.	Part No.	Dimension mm							Weight/ 100 pcs. ~ kg	Packing unit/pcs
			d1	a	b	d2	d4	c1	l3		
6	M5	41R5	3.5	9	10	5.5	6.5	7.5	9	0.59	50
	M6	41R6	3.5	9	12	6.5	6.5	7.5	10	0.58	50
	M8	41R8	3.5	9	14	8.5	6.5	10.0	13	0.61	50
	M10	41R10	3.5	9	17	10.5	6.5	12.0	15	0.65	50
	M12	41R12	3.5	9	19	13.0	6.5	13.0	17	0.62	50
10	M5	42R5	4.5	10	12	5.5	7.0	6.5	10	0.57	50
	M6	42R6	4.5	10	12	6.5	7.0	6.5	10	0.57	50
	M8	42R8	4.5	10	15	8.5	7.0	10.0	13	0.63	50
	M10	42R10	4.5	10	17	10.5	7.0	12.0	15	0.66	50
	M12	42R12	4.5	10	19	13.0	7.0	13.0	18	0.81	50
16	M5	43R5	5.5	13	12	5.5	8.5	7.5	10	1.01	50
	M6	43R6	5.5	13	12	6.5	8.5	7.5	11	1.01	50
	M8	43R8	5.5	13	15	8.5	8.5	10.0	13	1.08	50
	M10	43R10	5.5	13	17	10.5	8.5	12.0	15	1.09	50
	M12	43R12	5.5	13	19	13.0	8.5	13.0	18	1.15	50
25	M5	44R5	7.0	15	14	5.5	10.0	7.5	11	1.40	25
	M6	44R6	7.0	15	14	6.5	10.0	7.5	11	1.32	25
	M8	44R8	7.0	15	16	8.5	10.0	10.0	13	1.44	25
	M10	44R10	7.0	15	18	10.5	10.0	12.0	15	1.49	25
	M12	44R12	7.0	15	19	13.0	10.0	13.0	18	1.44	25
35	M14	44R14	7.0	15	21	15.0	10.0	14.5	20	1.55	25
	M6	45R6	8.5	17	17	6.5	12.0	7.5	11	2.05	25
	M8	45R8	8.5	17	17	8.5	12.0	10.0	13	2.20	25
	M10	45R10	8.5	17	19	10.5	12.0	12.0	15	2.28	25
	M12	45R12	8.5	17	21	13.0	12.0	13.0	18	2.38	25
	M14	45R14	8.5	17	21	15.0	12.0	14.5	20	2.41	25
	M16	45R16	8.5	17	26	17.0	12.0	16.0	22	2.40	25

See next page



Angled tubular cable lugs, Cu, 90° angled, standard type

Nominal cross section mm ²	Size of bolt dia.	Part No.	Dimension mm							Weight/ 100 pcs. ~ kg	Packing unit/pcs
			d1	a	b	d2	d4	c1	l3		
50	M6	46R6	10.0	19	20	6.5	14.0	10.0	13	3.34	25
	M8	46R8	10.0	19	20	8.5	14.0	10.0	13	3.28	25
	M10	46R10	10.0	19	20	10.5	14.0	12.0	16	3.47	25
	M12	46R12	10.0	19	23	13.0	14.0	13.0	18	3.42	25
	M14	46R14	10.0	19	23	15.0	14.0	14.5	20	3.55	25
	M16	46R16	10.0	19	28	17.0	14.0	16.0	22	3.58	25
	M20	46R20	10.0	19	30	21.0	14.0	19.0	24	3.15	25
70	M6	47R6	12.0	21	23	6.5	16.5	10.0	13	4.90	25
	M8	47R8	12.0	21	23	8.5	16.5	10.0	14	4.80	25
	M10	47R10	12.0	21	23	10.5	16.5	12.0	16	4.88	25
	M12	47R12	12.0	21	23	13.0	16.5	13.0	18	4.99	25
	M14	47R14	12.0	21	23	15.0	16.5	14.5	20	5.38	25
	M16	47R16	12.0	21	28	17.0	16.5	16.0	22	5.35	25
	M20	47R20	12.0	21	30	21.0	16.5	19.0	24	5.30	25
95	M8	48R8	13.5	25	26	8.5	18.0	12.0	14	5.89	25
	M10	48R10	13.5	25	26	10.5	18.0	12.0	17	5.88	25
	M12	48R12	13.5	25	26	13.0	18.0	13.0	18	5.93	25
	M14	48R14	13.5	25	26	15.0	18.0	14.5	20	6.03	25
	M16	48R16	13.5	25	28	17.0	18.0	16.0	22	6.17	25
	M20	48R20	13.5	25	36	21.0	18.0	22.0	24	6.42	25
	M8	49R8	15.0	26	28	8.5	19.5	14.0	16	7.26	10
120	M10	49R10	15.0	26	28	10.5	19.5	14.0	17	7.30	10
	M12	49R12	15.0	26	28	13.0	19.5	14.0	18	7.19	10
	M14	49R14	15.0	26	28	15.0	19.5	15.0	20	7.30	10
	M16	49R16	15.0	26	30	17.0	19.5	16.0	22	7.35	10
	M20	49R20	15.0	26	36	21.0	19.5	22.0	24	7.60	10
	M8	50R8	16.5	30	31	8.5	21.0	14.0	16	8.41	10
150	M10	50R10	16.5	30	31	10.5	21.0	14.0	17	8.27	10
	M12	50R12	16.5	30	31	13.0	21.0	15.0	18	8.34	10
	M14	50R14	16.5	30	31	15.0	21.0	15.0	20	8.52	10
	M16	50R16	16.5	30	31	17.0	21.0	16.0	22	8.62	10
	M20	50R20	16.5	30	36	21.0	21.0	22.0	24	9.10	10
185	M10	51R10	19.0	30	35	10.5	24.0	18.0	22	12.17	10
	M12	51R12	19.0	30	35	13.0	24.0	18.0	22	11.97	10
	M14	51R14	19.0	30	35	15.0	24.0	18.0	22	11.77	10
	M16	51R16	19.0	30	35	17.0	24.0	18.0	22	11.53	10
	M20	51R20	19.0	30	39	21.0	24.0	22.0	24	12.00	10
240	M10	52R10	21.0	35	39	10.5	26.0	21.5	22	15.60	10
	M12	52R12	21.0	35	39	13.0	26.0	21.5	22	15.60	10
	M14	52R14	21.0	35	39	15.0	26.0	21.5	22	15.41	10
	M16	52R16	21.0	35	39	17.0	26.0	21.5	22	15.18	10
	M20	52R20	21.0	35	39	21.0	26.0	21.5	24	14.80	10
300	M12	53R12	23.5	44	43	13.0	29.5	24.0	24	23.60	5
	M14	53R14	23.5	44	43	15.0	29.5	24.0	24	23.40	5
	M16	53R16	23.5	44	43	17.0	29.5	24.0	24	20.99	5
	M20	53R20	23.5	44	43	21.0	29.5	24.0	24	22.70	5
400	M12	54R12	27.0	44	49	13.0	34.0	24.0	24	32.53	5
	M14	54R14	27.0	44	49	15.0	34.0	24.0	24	33.40	5
	M16	54R16	27.0	44	49	17.0	34.0	24.0	24	32.60	5
	M20	54R20	27.0	44	49	21.0	34.0	24.0	24	31.80	5



Angled tubular cable lugs, Cu, 45° angled, standard type

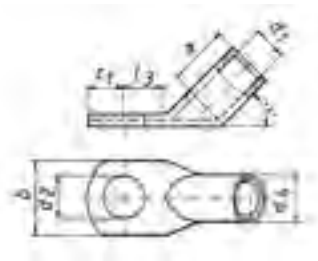

- ▶ For multi-stranded, round conductors e.g. to DIN EN 60228
- ▶ For pre-rounded multi-stranded sector shaped conductors
- ▶ Flat contact surface by special angle pressing technology

Characteristics

- Annealed material optimises material and crimping properties
- Simple cable entry due to internal chamfer
- Item identification on cable lug

Material

- Copper (EN13600)

Surface

- Tin-plated to protect against corrosion

Technical instructions

- Tool: see page 38
- Sleeves for compacted conductors and sleeves for 3-core and 4-core cables, see chapter „Sleeves for compacted conductors and sector shaped conductors - Cu“
- In combination with EKM 60 ID suitable for fine-stranded conductors

Additional information

- Also available as featured article with inspection hole, part number appendix „MS“

Nominal cross section mm ²	Size of bolt dia.	Part No.	Dimension mm							Weight/ 100 pcs. ~ kg	Packing unit/pcs
			d1	a	b	d2	d4	c1	l3		
6	M5	41R545	3.5	9	10	5.5	6.5	7.5	9	0.60	50
	M6	41R645	3.5	9	12	6.5	6.5	7.5	10	0.58	50
	M8	41R845	3.5	9	14	8.5	6.5	10.0	13	0.68	50
	M10	41R1045	3.5	9	17	10.5	6.5	12.0	15	0.70	50
	M12	41R1245	3.5	9	19	13.0	6.5	13.0	17	0.70	50
10	M5	42R545	4.5	10	12	5.5	7.0	6.5	10	0.57	50
	M6	42R645	4.5	10	12	6.5	7.0	6.5	10	0.57	50
	M8	42R845	4.5	10	15	8.5	7.0	10.0	13	0.63	50
	M10	42R1045	4.5	10	17	10.5	7.0	12.0	15	0.68	50
	M12	42R1245	4.5	10	19	13.0	7.0	13.0	18	0.68	50
16	M5	43R545	5.5	13	12	5.5	8.5	7.5	10	1.01	50
	M6	43R645	5.5	13	12	6.5	8.5	7.5	11	1.06	50
	M8	43R845	5.5	13	15	8.5	8.5	10.0	13	1.15	50
	M10	43R1045	5.5	13	17	10.5	8.5	12.0	15	1.09	50
	M12	43R1245	5.5	13	19	13.0	8.5	13.0	18	1.15	50
25	M5	44R545	7.0	15	14	5.5	10.0	7.5	11	1.40	25
	M6	44R645	7.0	15	14	6.5	10.0	7.5	11	1.32	25
	M8	44R845	7.0	15	16	8.5	10.0	10.0	13	1.44	25
	M10	44R1045	7.0	15	18	10.5	10.0	12.0	15	1.49	25
	M12	44R1245	7.0	15	19	13.0	10.0	13.0	18	1.44	25
35	M14	44R1445	7.0	15	21	15.0	10.0	14.5	20	1.55	25
	M6	45R645	8.5	17	17	6.5	12.0	7.5	11	2.05	25
	M8	45R845	8.5	17	17	8.5	12.0	10.0	13	2.20	25
	M10	45R1045	8.5	17	19	10.5	12.0	12.0	15	2.28	25
	M12	45R1245	8.5	17	21	13.0	12.0	13.0	18	2.38	25
35	M14	45R1445	8.5	17	21	15.0	12.0	14.5	20	2.41	25
	M16	45R1645	8.5	17	26	17.0	12.0	16.0	22	2.40	25

See next page



Angled tubular cable lugs, Cu, 45° angled, standard type

Nominal cross section mm ²	Size of bolt dia.	Part No.	Dimension mm							Weight/100 pcs. ~ kg	Packing unit/pcs
			d1	a	b	d2	d4	c1	l3		
50	M6	46R645	10.0	19	20	6.5	14.0	10.0	13	3.43	25
	M8	46R845	10.0	19	20	8.5	14.0	10.0	13	3.28	25
	M10	46R1045	10.0	19	20	10.5	14.0	12.0	16	3.47	25
	M12	46R1245	10.0	19	23	13.0	14.0	13.0	18	3.42	25
	M14	46R1445	10.0	19	23	15.0	14.0	14.5	20	3.65	25
	M16	46R1645	10.0	19	28	17.0	14.0	16.0	22	3.76	25
70	M20	46R2045	10.0	19	30	21.0	14.0	19.0	24	3.30	25
	M6	47R645	12.0	21	23	6.5	16.5	10.0	13	5.06	25
	M8	47R845	12.0	21	23	8.5	16.5	10.0	14	5.06	25
	M10	47R1045	12.0	21	23	10.5	16.5	12.0	16	5.25	25
	M12	47R1245	12.0	21	23	13.0	16.5	13.0	18	5.30	25
	M14	47R1445	12.0	21	23	15.0	16.5	14.5	20	5.60	25
95	M16	47R1645	12.0	21	28	17.0	16.5	16.0	22	5.61	25
	M20	47R2045	12.0	21	30	21.0	16.5	19.0	24	5.60	25
	M8	48R845	13.5	25	26	8.5	18.0	12.0	14	6.19	25
	M10	48R1045	13.5	25	26	10.5	18.0	12.0	17	5.70	25
	M12	48R1245	13.5	25	26	13.0	18.0	13.0	18	6.67	25
	M14	48R1445	13.5	25	26	15.0	18.0	14.5	20	6.60	25
120	M16	48R1645	13.5	25	28	17.0	18.0	16.0	22	6.78	25
	M20	48R2045	13.5	25	36	21.0	18.0	22.0	24	6.80	25
	M8	49R845	15.0	26	28	8.5	19.5	14.0	16	7.92	10
	M10	49R1045	15.0	26	28	10.5	19.5	14.0	17	7.99	10
	M12	49R1245	15.0	26	28	13.0	19.5	14.0	18	7.96	10
	M14	49R1445	15.0	26	28	15.0	19.5	15.0	20	7.94	10
150	M16	49R1645	15.0	26	30	17.0	19.5	16.0	22	8.26	10
	M20	49R2045	15.0	26	36	21.0	19.5	22.0	24	8.20	10
	M8	50R845	16.5	30	31	8.5	21.0	14.0	16	9.00	10
	M10	50R1045	16.5	30	31	10.5	21.0	14.0	17	9.15	10
	M12	50R1245	16.5	30	31	13.0	21.0	15.0	18	8.75	10
	M14	50R1445	16.5	30	31	15.0	21.0	15.0	20	9.20	10
185	M16	50R1645	16.5	30	31	17.0	21.0	16.0	22	9.22	10
	M10	51R1045	19.0	30	35	10.5	24.0	18.0	22	13.30	10
	M12	51R1245	19.0	30	35	13.0	24.0	18.0	22	13.32	10
	M14	51R1445	19.0	30	35	15.0	24.0	18.0	22	13.40	10
	M16	51R1645	19.0	30	35	17.0	24.0	18.0	22	12.80	10
	M20	51R2045	19.0	30	39	21.0	24.0	22.0	24	13.10	10
240	M10	52R1045	21.0	35	39	10.5	26.0	21.5	22	16.28	10
	M12	52R1245	21.0	35	39	13.0	26.0	21.5	22	16.80	10
	M14	52R1445	21.0	35	39	15.0	26.0	21.5	22	16.40	10
	M16	52R1645	21.0	35	39	17.0	26.0	21.5	22	16.10	10
	M20	52R2045	21.0	35	39	21.0	26.0	21.5	24	16.10	10
	300	M12	53R1245	23.5	44	43	13.0	29.5	24.0	24	24.08
M14		53R1445	23.5	44	43	15.0	29.5	24.0	24	24.20	5
M16		53R1645	23.5	44	43	17.0	29.5	24.0	24	23.23	5
M20		53R2045	23.5	44	43	21.0	29.5	24.0	24	23.50	5
400	M12	54R1245	27.0	44	49	13.0	34.0	24.0	24	34.00	5
	M14	54R1445	27.0	44	49	15.0	34.0	24.0	24	33.40	5
	M16	54R1645	27.0	44	49	17.0	34.0	24.0	24	34.28	5
	M20	54R2045	27.0	44	49	21.0	34.0	24.0	24	31.80	5



Butt connectors, Cu, standard type

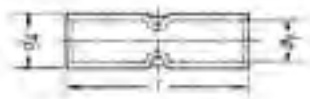

- ▶ For multi-stranded, round conductors e.g. to DIN EN 60228
- ▶ For pre-rounded multi-stranded sector shaped conductors
- ▶ Simple cable entry for internal chamfer



Characteristics

- Simple and safe processing due to butt mark
- Annealed material optimises material and crimping properties
- Item identification on cable lug



Material

- Copper (EN13600)



Surface

- Tin-plated to protect against corrosion



Technical instructions

- In combination with EKM 60 ID suitable for fine-stranded conductors
- Tool: see page 38
- Sleeves for compacted conductors and sleeves for 3-core and 4-core cables, see chapter „Sleeves for compacted conductors and sector shaped conductors - Cu“



Additional information

- Also available as featured article without buttmark, part number appendix „OM“

Nominal cross section mm ²	Part No.	Dimension mm			Weight/ 100 pcs. ~ kg	Packing unit/pcs
		d1	d4	l		
0.75	17R	1.3	2.8	20	0.09	100
1.5	18R	1.8	3.3	25	0.12	100
2.5	19R	2.3	4.2	25	0.20	100
4	20R	3.0	5.0	25	0.26	100
6	21R	3.5	6.5	25	0.50	100
10	22R	4.5	7.0	30	0.72	100
16	23R	5.5	8.5	35	1.00	100
25	24R	7.0	10.0	40	1.41	50
35	25R	8.5	12.0	45	2.24	50
50	26R	10.0	14.0	50	3.36	50
70	27R	12.0	16.5	55	4.87	50
95	28R	13.5	18.0	60	5.91	25
120	29R	15.0	19.5	65	7.00	25
150	30R	16.5	21.0	70	8.12	10
185	31R	19.0	24.0	75	10.06	10
240	32R	21.0	26.0	85	13.82	10
300	33R	23.5	29.5	100	21.94	5
400	34R	27.0	34.0	100	29.65	5

Parallel connectors, Cu, standard type



- ▶ For multi-stranded round conductors, e.g. to DIN EN 60228 Cl. 2
- ▶ Ideal for connecting differing cable cross-sections
- ▶ Simple cable entry due to internal chamfer



Characteristics

- Annealed material optimises material and crimping properties



Material

- Copper (EN13600)

Surface

- Tin-plated to protect against corrosion

Technical instructions

- Tool: see page 38

Additional information

- The stated nominal cross-section corresponds to the total cross-section of the cable
- Additional conductor types and combinations on request

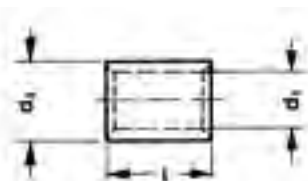

Nominal cross section mm ²	Part No.	Dimension mm			Weight/ 100 pcs. ~ kg	Packing unit/pcs
		d1	d4	l		
1.5	148R	1.8	3.3	5	0.03	100
2.5	149R	2.3	4.2	5	0.04	100
4	150R	3.0	5.0	7	0.08	100
6	151R	4.0	6.0	7	0.09	100
10	152R	4.5	7.0	9	0.17	100
16	153R	5.5	8.5	10	0.28	100
25	154R	7.0	10.0	13	0.44	100
35	155R	8.5	12.0	16	0.78	100
50	156R	10.0	14.0	19	1.22	100
70	157R	12.0	16.5	19	1.62	50
95	158R	13.5	18.0	20	1.90	50
120	159R	15.0	19.5	22	2.28	50
150	160R	16.5	21.0	26	3.00	50
185	161R	19.0	24.0	30	4.37	50
240	162R	21.0	26.0	32	5.30	25
300	163R	23.5	29.5	36	8.05	25



T-connectors, Cu, standard type

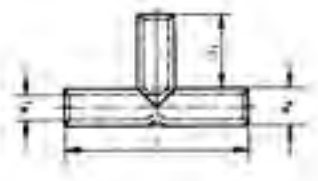

- ▶ For multi-stranded, round conductors e.g. to DIN EN 60228
- ▶ For pre-rounded multi-stranded sector shaped conductors
- ▶ Special version for cable tap conductors



Characteristics

- Annealed material optimises material and crimping properties
- Simple cable entry due to internal chamfer



Material

- Copper (EN13600)



Surface

- Tin-plated to protect against corrosion



Technical instructions

- Tool: see page 38
- Sleeves for compacted conductors and sleeves for 3-core and 4-core cables, see chapter „Sleeves for compacted conductors and sector shaped conductors - Cu“



Nominal cross section mm ²	Part No.	Dimension mm				Weight/ 100 pcs. ~ kg	Packing unit/pcs
		d1	d4	l	l1		
1.5	TV15	1.8	3.3	30	12	0.23	50
2.5	TV2.5	2.3	4.2	30	12	0.37	50
4	TV4	3.0	5.0	30	12	0.45	50
6	TV6	4.0	6.0	35	14	0.73	50
10	TV10	4.5	7.0	35	14	1.05	50
16	TV16	5.5	8.5	50	21	2.20	50
25	TV25	7.0	10.0	55	23	2.90	25
35	TV35	8.5	12.0	70	30	5.20	25
50	TV50	10.0	14.0	80	34	7.90	25
70	TV70	12.0	16.5	85	35	11.20	10
95	TV95	13.5	18.0	90	36	13.00	10
120	TV120	15.0	19.5	95	38	14.70	10
150	TV150	16.5	21.0	110	44	18.90	10
185	TV185	19.0	24.0	115	45	25.00	5
240	TV240	21.0	26.0	130	52	31.10	5



Cross-connectors, Cu, standard type

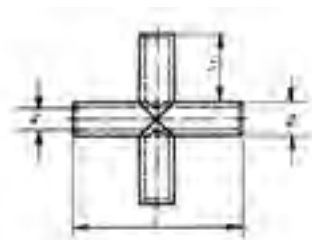
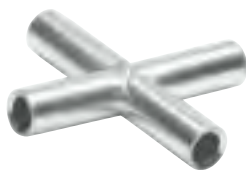

- ▶ For multi-stranded round conductors, e.g. to DIN EN 60228 Cl. 2
- ▶ For pre-rounded multi-stranded sector shaped conductors
- ▶ Version for double cable tap conductors



Characteristics

- Annealed material optimises material and crimping properties
- Simple cable entry due to internal chamfer



Material

- Copper (EN13600)



Surface

- Tin-plated to protect against corrosion



Technical instructions

- Tool: see page 38
- Sleeves for compacted conductors and sleeves for 3-core and 4-core cables, see chapter „Sleeves for compacted conductors and sector shaped conductors - Cu“



Nominal cross section mm ²	Part No.	Dimension mm				Weight/ 100 pcs. ~ kg	Packing unit/pcs
		d1	d4	l	l1		
1.5	KV15	1.8	3.3	30	12	0.320	25
2.5	KV2.5	2.3	4.2	30	12	0.490	25
4	KV4	3.0	5.0	30	12	0.650	25
6	KV6	4.0	6.0	35	14	0.950	25
10	KV10	4.5	7.0	35	14	1.350	25
16	KV16	5.5	8.5	50	21	2.950	25
25	KV25	7.0	10.0	55	23	4.000	15
35	KV35	8.5	12.0	70	30	6.900	15
50	KV50	10.0	14.0	80	34	10.400	15
70	KV70	12.0	16.5	85	35	14.600	15
95	KV95	13.5	18.0	90	36	17.100	15
120	KV120	15.0	19.5	95	38	19.400	5
150	KV150	16.5	21.0	110	44	24.100	5
185	KV185	19.0	24.0	115	45	32.100	5
240	KV240	21.0	26.0	130	52	41.100	5



Insulated tubular cable lugs, Cu, standard type

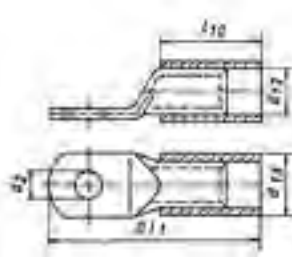

- ▶ For multi-stranded round conductors, e.g. to DIN EN 60228 Cl. 2
- ▶ For pre-rounded multi-stranded sector shaped conductors
- ▶ No additional insulation of the crimped connection required
- ▶ Is directly crimped with the insulation

Characteristics

- Annealed material optimises material and crimping properties
- Simple and safe connection due to flat contact surfaces and internal chamfer
- Heat resistant to 105° C

Material

- Cable lug: Copper to EN 13600
- Insulation sleeve: PA, halogen-free

Surface

- Tin-plated to protect against corrosion

Technical instructions

- Tool: see page 40
- Dimensions of tubular cable lugs can be found from page 14
- Sleeves for compacted conductors and sleeves for 3-core and 4-core cables, see chapter „Sleeves for compacted conductors and sector shaped conductors - Cu“

Additional information

- Also available as featured article with inspection hole, part number appendix „MS“

Nominal cross section mm ²	Size of bolt dia.	Part No.	Colour	Dimension mm					weight 100 pcs. ~kg Cu	weight 100 pcs. ~kg Total	Packing unit/ pcs
				d12	d13	d2	G1	l10			
10	M5	602R5	■	7.0	9.0	5.5	35.5	17.0	0.50	0.548	25
	M6	602R6	■	7.0	9.0	6.5	35.5	17.0	0.49	0.538	25
	M8	602R8	■	7.0	9.0	8.5	42.0	17.0	0.58	0.628	25
	M10	602R10	■	7.0	9.0	10.5	46.0	17.0	0.62	0.668	25
	M12	602R12	■	7.0	9.0	13.0	49.0	17.0	0.64	0.688	25
16	M5	603R5	■	8.5	10.5	5.5	39.5	21.0	0.84	0.907	25
	M6	603R6	■	8.5	10.5	6.5	41.3	21.0	0.86	0.927	25
	M8	603R8	■	8.5	10.5	8.5	45.5	21.0	0.93	0.997	25
	M10	603R10	■	8.5	10.5	10.5	49.5	21.0	0.99	1.057	25
	M12	603R12	■	8.5	10.5	13.0	54.0	21.0	1.02	1.087	25
25	M5	604R5	■	10.0	12.0	5.5	45.0	24.0	1.22	1.312	25
	M6	604R6	■	10.0	12.0	6.5	46.5	24.0	1.20	1.292	25
	M8	604R8	■	10.0	12.0	8.5	51.0	24.0	1.31	1.402	25
	M10	604R10	■	10.0	12.0	10.5	55.0	24.0	1.57	1.662	25
	M12	604R12	■	10.0	12.0	13.0	57.0	24.0	1.39	1.482	25
35	M14	604R14	■	10.0	12.0	15.0	61.5	24.0	1.49	1.582	25
	M6	605R6	■	12.0	14.5	6.5	49.5	27.0	1.85	2.010	25
	M8	605R8	■	12.0	14.5	8.5	54.0	27.0	2.00	2.160	25
	M10	605R10	■	12.0	14.5	10.5	59.0	27.0	2.13	2.290	25
	M12	605R12	■	12.0	14.5	13.0	61.0	27.0	2.12	2.280	25
	M14	605R14	■	12.0	14.5	15.0	64.5	27.0	2.18	2.340	25
	M16	605R16	■	12.0	14.5	17.0	68.0	27.0	2.24	2.400	25

See next page



Insulated tubular cable lugs, Cu, standard type

Nominal cross section mm ²	Size of bolt dia.	Part No.	Colour	Dimension mm					Gewicht 100 St. ~kg Cu	Gewicht 100 St. ~kg Ges.	Packing unit/ pcs
				d12	d13	d2	G1	l10			
50	M6	606R6	■	14.0	16.5	6.5	59.0	32.0	3.00	3.220	25
	M8	606R8	■	14.0	16.5	8.5	59.0	32.0	2.93	3.150	25
	M10	606R10	■	14.0	16.5	10.5	63.0	32.0	3.08	3.300	25
	M12	606R12	■	14.0	16.5	13.0	68.0	32.0	3.23	3.450	25
	M14	606R14	■	14.0	16.5	15.0	71.5	32.0	3.32	3.540	25
	M16	606R16	■	14.0	16.5	17.0	77.0	32.0	3.38	3.600	25
	M20	606R20	■	14.0	16.5	21.0	83.5	32.0	3.46	3.680	25
70	M6	607R6	■	16.4	18.9	6.5	65.5	33.5	4.49	4.760	25
	M8	607R8	■	16.4	18.9	8.5	65.5	33.5	4.38	4.650	25
	M10	607R10	■	16.4	18.9	10.5	66.5	33.5	4.54	4.810	25
	M12	607R12	■	16.4	18.9	13.0	70.5	33.5	4.63	4.900	25
	M14	607R14	■	16.4	18.9	15.0	73.5	33.5	4.76	5.030	25
	M16	607R16	■	16.4	18.9	17.0	78.5	33.5	4.24	4.510	25
	M20	607R20	■	16.4	18.9	21.0	84.5	33.5	5.09	5.360	25
95	M8	608R8	■	17.8	20.8	8.5	74.0	40.0	5.44	5.85	25
	M10	608R10	■	17.8	20.8	10.5	74.0	40.0	5.40	5.81	25
	M12	608R12	■	17.8	20.8	13.0	76.0	40.0	5.56	5.97	25
	M14	608R14	■	17.8	20.8	15.0	79.5	40.0	5.62	6.03	25
	M16	608R16	■	17.8	20.8	17.0	84.0	40.0	5.82	6.23	25
	M20	608R20	■	17.8	20.8	21.0	96.0	40.0	6.71	7.12	25
120	M8	609R8	■	19.3	22.3	8.5	80.5	41.5	6.72	7.18	10
	M10	609R10	■	19.3	22.3	10.5	80.5	41.5	6.57	7.03	10
	M12	609R12	■	19.3	22.3	13.0	80.5	41.5	6.38	6.84	10
	M16	609R16	■	19.3	22.3	17.0	85.5	41.5	6.51	6.97	10



Insulated butt connectors, Cu, standard type



- ▶ For multi-stranded round conductors, e.g. to DIN EN 60228 Cl. 2
- ▶ For pre-rounded multi-stranded sector shaped conductors
- ▶ No additional insulation of the crimped connection required
- ▶ Is directly crimped with the insulation

Characteristics

- With buttmarks for precise cable insertion
- Annealed material optimises material and crimping properties
- Simple cable entry due to internal chamfer
- Heat resistant to 105° C

Material

- Connector: Copper (EN 13600)
- Insulation sleeve: PA, halogen-free

Surface

- Tin-plated to protect against corrosion

Technical instructions

- Tool: see page 40
- Dimensions of butt connectors can be found on page 21
- Sleeves for compacted conductors and sleeves for 3-core and 4-core cables, see chapter „Sleeves for compacted conductors and sector shaped conductors - Cu“

Nominal cross section mm ²	Part No.	Colour	Dimension mm			Gewicht 100 St. ~kg Cu	Gewicht 100 St. ~kg Ges.	Packing unit/pcs
			d12	d13	l10			
10	622R	■	7.0	9.0	42	0.72	0.84	25
16	623R	■	8.5	10.5	50	1.00	1.16	25
25	624R	■	10.0	12.0	57	1.41	1.63	25
35	625R	■	12.0	14.4	65	2.24	2.60	25
50	626R	■	14.0	16.4	72	3.36	3.81	25
70	627R	■	16.4	19.0	80	4.87	5.46	25
95	628R	■	17.8	20.8	87	5.91	6.74	25



Tubular cable lugs, blue connection®, Cu



- ▶ For compacted multi-stranded round conductors to DIN EN 60228
- ▶ Accurate assignment of crimping tool/crimping die through colour-coding system
- ▶ Fewer crimps due to max. crimping width
- ▶ Reduced costs due to compact dimensions

Characteristics

- Rigid design thanks to special shaped radius
- Processing takes place without the use of additional sleeves
- Annealed material optimises material and crimping properties
- Simple and safe connection due to flat contact surfaces and internal chamfer

Material

- Copper (EN13600)

Surface

- Tin-plated to protect against corrosion

Technical instructions

- Tool: see page 41

Additional information

- 10-300 mm² IEC-tested

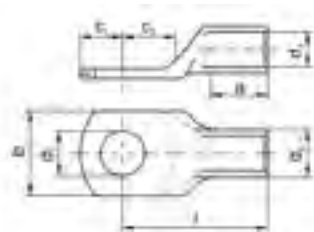

Nominal cross section mm ²	Size of bolt dia.	Part No.	Dimension mm								Weight/100 pcs. ~ kg	Packing unit/pcs
			d1	a	b	d2	d4	c1	c2	l		
6	M5	6B5	3.20	9.0	10.50	5.30	5.00	5.00	6.50	20.50	0.24	50
	M6	6B6	3.20	9.0	11.00	6.40	5.00	6.00	8.00	22.00	0.26	50
	M8	6B8	3.20	9.0	12.50	8.40	5.00	8.00	10.00	24.00	0.29	50
	M10	6B10	3.20	9.00	14.00	10.50	5.00	10.00	11.50	25.50	0.30	50
10	M5	10B5	4.10	9.00	11.50	5.30	6.50	5.00	6.50	21.00	0.35	50
	M6	10B6	4.10	9.00	12.00	6.40	6.50	6.00	8.00	22.50	0.39	50
	M8	10B8	4.10	9.00	14.00	8.40	6.50	8.00	10.00	24.50	0.43	50
	M10	10B10	4.10	9.00	15.00	10.50	6.50	10.00	11.50	26.00	0.44	50
16	M6	16B6	5.50	10.0	13.50	6.40	7.70	6.00	8.00	25.00	0.61	50
	M8	16B8	5.50	10.0	15.00	8.40	7.70	8.00	10.00	27.00	0.65	50
	M10	16B10	5.50	10.00	16.50	10.50	7.70	10.00	11.50	28.00	0.69	50
	M12	16B12	5.50	10.00	18.50	13.00	7.70	12.00	13.00	29.50	0.72	50
25	M6	25B6	6.60	10.0	15.00	6.40	9.00	6.00	8.00	25.50	0.81	25
	M8	25B8	6.60	10.0	16.00	8.40	9.00	8.00	10.00	27.50	0.88	50
	M10	25B10	6.60	10.0	18.00	10.50	9.00	10.00	11.50	29.00	0.93	50
	M12	25B12	6.60	10.0	19.50	13.00	9.00	12.00	13.00	30.50	0.97	25
35	M8	35B8	7.70	11.0	18.00	8.40	10.60	8.00	10.00	29.50	1.34	50
	M10	35B10	7.70	11.0	19.50	10.50	10.60	10.00	11.50	31.00	1.42	50
	M12	35B12	7.70	11.0	21.00	13.00	10.60	12.00	13.00	32.50	1.48	25
	M8	50B8	9.20	11.0	19.00	8.40	12.40	8.00	10.00	31.00	1.87	25
50	M10	50B10	9.20	11.0	21.00	10.50	12.40	10.00	11.50	32.50	1.95	25
	M12	50B12	9.20	11.0	23.00	13.00	12.40	12.00	13.00	34.00	2.05	25
	M8	70B8	11.00	21.0	22.00	8.40	14.60	8.00	10.00	41.50	3.17	25
70	M10	70B10	11.00	21.0	24.00	10.50	14.60	10.00	11.50	43.00	3.33	25
	M12	70B12	11.00	21.0	25.00	13.00	14.60	12.00	13.00	44.50	3.46	25
	M16	70B16	11.00	21.0	28.00	17.00	14.60	15.00	17.00	48.50	3.73	10
95	M10	95B10	13.00	21.0	26.00	10.50	17.00	10.00	11.50	44.50	4.55	25
	M12	95B12	13.00	21.0	28.00	13.00	17.00	12.00	13.00	46.00	4.75	25
	M16	95B16	13.00	21.0	30.00	17.00	17.00	15.00	17.00	50.00	5.01	10

See next page



Rohrkabelschuhe, blue connection®, Cu

Nominal cross section mm ²	Size of bolt dia.	Part No.	Dimension mm								Weight/ 100 pcs. ~ kg	Packing unit/pcs
			d1	a	b	d2	d4	c1	c2	l		
120	M10	120B10	14.50	22.0	28.00	10.50	19.00	10.00	11.50	47.00	6.02	25
	M12	120B12	14.50	22.0	29.50	13.00	19.00	12.00	13.00	48.50	6.26	25
	M16	120B16	14.50	22.0	32.00	17.00	19.00	15.00	17.00	52.50	6.73	10
150	M10	150B10	16.20	22.0	30.00	10.50	21.00	10.00	11.50	48.50	7.41	10
	M12	150B12	16.20	22.0	32.00	13.00	21.00	12.00	13.00	50.00	7.71	10
185	M10	185B10	18.00	24.0	33.00	10.50	23.00	10.00	11.50	52.00	9.21	10
	M12	185B12	18.00	24.0	33.00	13.00	23.00	12.00	13.00	53.50	9.43	10
	M16	185B16	18.00	24.0	36.00	17.00	23.00	15.00	17.00	57.70	10.14	10
240	M12	240B12	20.60	24.0	38.00	13.00	26.00	12.00	13.00	56.00	12.46	10
	M16	240B16	20.60	24.0	38.00	17.00	26.00	15.00	17.00	60.00	13.24	10
300	M12	300B12	23.10	33.0	41.00	13.00	28.00	12.00	13.00	67.00	14.39	5
	M16	300B16	23.10	33.0	41.00	17.00	28.00	15.00	17.00	71.00	15.27	5

Butt connectors, blue connection®, Cu



- ▶ For compacted multi-stranded round conductors, e.g. to DIN EN 60228 Cl. 2
- ▶ Accurate assignment of crimping tool/crimping die through colour-coding system
- ▶ Fewer crimps due to max. crimping width
- ▶ Reduced costs due to compact dimensions

Characteristics

- Processing takes place without the use of additional sleeves
- Annealed material optimises material and crimping properties
- Simple cable entry due to internal chamfer

Material

- Copper (EN13600)

Surface

- Tin-plated to protect against corrosion

Technical instructions

- Tool: see page 41

Additional information

- 10-300 mm² IEC-tested

Nominal cross section mm ²	Part No.	Dimension mm			Weight/ 100 pcs. ~ kg	Packing unit/pcs
		d1	d4	l		
6	6B	3.20	5.00	25.00	0.255	50
10	10B	4.10	6.50	25.00	0.360	50
16	16B	5.50	7.70	27.00	0.543	50
25	25B	6.60	9.00	27.00	0.699	50
35	35B	7.70	10.60	28.00	1.026	50
50	50B	9.20	12.40	28.00	1.334	25
70	70B	11.00	14.60	48.00	3.065	25
95	95B	13.00	17.00	48.00	3.987	25
120	120B	14.50	19.00	50.00	5.157	25
150	150B	16.20	21.00	52.00	6.379	10
185	185B	18.00	23.00	56.00	7.889	10
240	240B	20.60	26.00	58.00	10.000	10
300	300B	23.10	28.00	76.00	13.079	5



Tubular cable lugs, Cu, solid conductor type

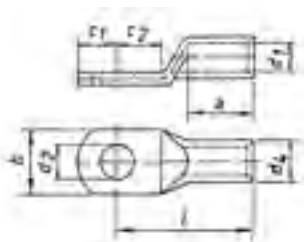

- ▶ For single-stranded round conductors, e.g. to DIN EN 60228 Cl. 1
- ▶ For pre-rounded sector shaped conductors
- ▶ Safe and secure connecting of solid conductors

Characteristics

- Annealed material optimises material and crimping properties
- Simple and safe connection due to flat contact surfaces and internal chamfer

Material

- Copper (EN13600)

Surface

- Tin-plated to protect against corrosion

Technical instructions

- Tool: see page 44

Nominal cross section mm ²	Size of bolt dia.	Part No.	Dimension mm								Weight/100 pcs. ~ kg	Packing unit/pcs
			d1	a	b	d2	d4	c1	c2	l		
6	M5	SR65	3.0	8	9.0	5.3	5	4.75	6.0	17.0	0.213	25
	M6	SR66	3.0	8	10.0	6.5	5	6.50	6.5	19.0	0.220	25
10		SR106	4.0	9	10.0	6.5	6	7.00	6.5	19.0	0.300	25
	M8	SR108	4.0	9	14.0	8.5	6	8.50	9.5	22.0	0.320	25
16	M6	SR166	5.0	12	12.5	6.5	8	6.50	7.0	23.5	0.800	25
	M8	SR168	5.0	12	15.0	8.5	8	9.00	9.0	26.0	0.900	25
25	M6	SR256	6.2	15	14.0	6.5	10	7.50	7.5	30.0	1.560	25
	M8	SR258	6.2	15	16.0	8.5	10	10.00	10.0	32.0	1.700	25
35	M6	SR356	7.0	15	14.0	6.5	10	7.50	7.5	30.0	1.200	25
	M8	SR358	7.0	15	16.0	8.5	10	10.00	10.0	32.0	1.310	25
	M10	SR3510	7.0	15	18.0	10.5	10	12.00	12.0	34.0	1.570	25
50	M6	SR506	8.5	17	17.0	6.5	12	7.50	7.5	32.0	1.850	25
	M8	SR508	8.5	17	17.0	8.5	12	10.00	10.0	34.0	2.000	25
	M10	SR5010	8.5	17	19.0	10.5	12	12.00	12.0	37.0	2.130	25

Butt connectors, Cu, solid conductor type

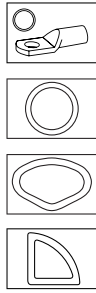
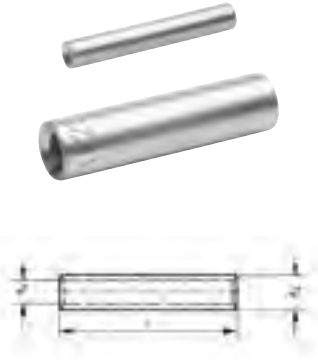

- ▶ For single-stranded round conductors, e.g. to DIN EN 60228 Cl. 1
- ▶ Also pre-rounded sector shaped conductors
- ▶ Safe and secure connecting of solid conductors

Characteristics

- Annealed material optimises material and crimping properties
- Simple cable entry due to internal chamfer

Material

- Copper (EN13600)

Surface

- Tin-plated to protect against corrosion

Technical instructions

- Tool: see page 44

Nominal cross section mm ²	Part No.	Dimension mm			Weight/ 100 pcs. ~ kg	Packing unit/pcs
		d1	d4	l		
1.5-2.5	SV1525	1.9	3.9	25	0.210	100
4	SV4	2.4	4.4	25	0.240	100
6	SV6	3.0	5.0	25	0.275	100
10	SV10	4.0	6.0	25	0.350	100
16	SV16	5.0	8.0	35	0.960	100
25	SV25	6.2	10.0	40	1.700	50
35	SV35	7.0	10.0	40	1.420	50
50	SV50	8.5	12.0	70	3.550	50

T-connectors, Cu, solid conductor type

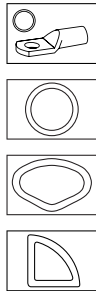
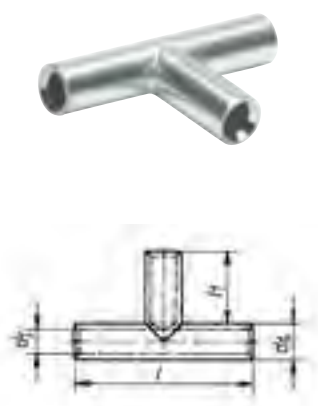

- ▶ For single-stranded round conductors, e.g. to DIN EN 60228 Cl. 1
- ▶ Also pre-rounded sector shaped conductors
- ▶ Safe and secure connecting of solid conductors
- ▶ Special version for cable tap conductors

Characteristics

- Annealed material optimises material and crimping properties
- Simple cable entry due to internal chamfer

Material

- Copper (EN13600)

Surface

- Tin-plated to protect against corrosion

Technical instructions

- Tool: see page 44

Nominal cross section mm ²	Part No.	Dimension mm				Draht-Ø mm	Weight/ 100 pcs. ~ kg	Packing unit/pcs
		d1	d4	l	l1			
1.5-2.5	STV1525	1.9	3.9	30	12	1.38/1.78	0.34	50
4	STV4	2.4	4.4	30	12	2.25	0.40	50
6	STV6	3.0	5.0	30	12	2.75	0.48	50
10	STV10	4.0	6.0	35	14	3.55	0.72	50
16	STV16	5.0	8.0	35	14	4.5	1.40	50
25	STV25	6.2	10.0	50	21	5.65	3.20	25
35	STV35	7.0	10.0	55	23	6.7	2.95	25
50	STV50	8.5	12.0	76	32	8	5.60	25



Cross-connectors, Cu, solid conductor type

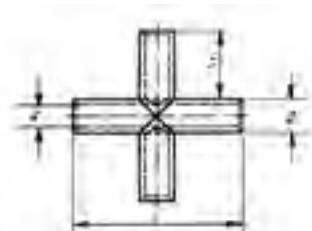

- ▶ For single-stranded round conductors, e.g. to DIN EN 60228 Cl. 1
- ▶ Also pre-rounded sector shaped conductors
- ▶ Safe and secure connecting of solid conductors
- ▶ Special version for double cable tap conductors

Characteristics

- Annealed material optimises material and crimping properties
- Simple cable entry due to internal chamfer

Material

- Copper (EN13600)

Surface

- Tin-plated to protect against corrosion

Technical instructions

- Tool: see page 44

Nominal cross section mm ²	Part No.	Dimension mm				Draht-Ø mm	Weight/100 pcs. ~ kg	Packing unit/pcs
		d1	d4	l	l1			
1.5-2.5	SKV1525	1.9	3.9	30	12	1.38/1.78	0.47	25
4	SKV4	2.4	4.4	30	12	2.25	0.56	25
6	SKV6	3.0	5.0	30	12	2.75	0.67	25
10	SKV10	4.0	6.0	35	14	3.55	0.92	25
16	SKV16	5.0	8.0	35	14	4.5	1.86	25
25	SKV25	6.2	10.0	50	21	5.65	4.20	15
35	SKV35	7.0	10.0	55	23	6.7	3.80	15
50	SKV50	8.5	12.0	76	32	8	7.35	15



Tubular cable lugs, Cu, F-series

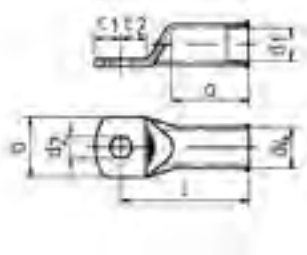

- ▶ For fine and superfine stranded round conductors, e.g. to DIN EN 60228 Cl. 5 and 6
- ▶ Pipe dimension adjusted for fine and superfine stranded conductors
- ▶ Special wide opening for the easy entry of fine conductors

Characteristics

- Annealed material optimises material and crimping properties
- To DIN EN 61373 class 1B vibration-tested
- Simple and safe connection due to flat contact surfaces and internal chamfer
- Reliable assignment owed to item designation on the cable lug

Material

- Copper (EN13600)

Surface

- Tin-plated to protect against corrosion

Technical instructions

- Tool: see page 42

Additional information

- Also available as featured article with inspection hole, part number appendix „MS“
- 10 - 240 mm² UL-tested

Nominal cross section mm ²	Size of bolt dia.	Part No.	Dimension mm								Weight/ 100 pcs. ~ kg	Packing unit/pcs
			d1	a	b	d2	d4	c1	c2	l		
10	M5	702F5	5.5	14	12	5.3	8.0	6.25	7.5	27	0.72	100
	M6	702F6	5.5	14	12	6.5	8.0	6.25	7.5	27	0.71	100
	M8	702F8	5.5	14	16	8.5	8.0	8.50	9.5	29	0.77	100
	M10	702F10	5.5	14	16	10.5	8.0	10.50	11.5	31	0.82	100
	M12	702F12	5.5	14	19	13.0	8.0	12.00	13.0	32	0.82	100
16	M5	703F5	6.6	15	13	5.3	9.5	6.25	7.5	30	1.10	100
	M6	703F6	6.6	15	13	6.5	9.5	6.25	7.5	30	1.07	100
	M8	703F8	6.6	15	16	8.5	9.5	10.00	10.0	32	1.21	100
	M10	703F10	6.6	15	17	10.5	9.5	12.00	12.0	34	1.28	100
	M12	703F12	6.6	15	19	13.0	9.5	13.00	13.0	35	1.28	100
25	M5	704F5	7.9	17	15	5.3	11.0	7.50	7.5	32	1.52	25
	M6	704F6	7.9	17	15	6.5	11.0	7.50	7.5	32	1.50	100
	M8	704F8	7.9	17	17	8.5	11.0	10.00	10.0	34	1.61	100
	M10	704F10	7.9	17	17	10.5	11.0	12.00	12.0	37	1.71	100
	M12	704F12	7.9	17	19	13.0	11.0	13.00	13.0	38	1.74	25
35	M6	705F6	9.2	19	17	6.5	12.5	7.50	7.5	35	1.91	100
	M8	705F8	9.2	19	18	8.5	12.5	10.00	10.0	37	2.08	100
	M10	705F10	9.2	19	18	10.5	12.5	12.00	12.0	40	2.24	100
	M12	705F12	9.2	19	19	13.0	12.5	13.00	13.0	41	2.22	25
	M14	705F14	9.2	19	21	15.0	12.5	14.50	14.5	43	2.41	25
50	M6	706F6	11.0	21	21	6.5	15.0	10.00	10.0	41	3.54	25
	M8	706F8	11.0	21	21	8.5	15.0	10.00	10.0	41	3.44	50
	M10	706F10	11.0	21	21	10.5	15.0	12.00	12.0	43	3.64	50
	M12	706F12	11.0	21	21	13.0	15.0	13.00	13.0	46	3.73	50
	M14	706F14	11.0	21	23	15.0	15.0	14.50	14.5	48	3.89	25
	M16	706F16	11.0	21	28	17.0	15.0	16.00	16.0	50	4.02	25

See next page



Tubular cable lugs, Cu, F-series

Nominal cross section mm ²	Size of bolt dia.	Part No.	Dimension mm								Weight/ 100 pcs. ~ kg	Packing unit/pcs
			d1	a	b	d2	d4	c1	c2	l		
70	M8	707F8	13.0	25	25	8.5	17.0	10.00	10.0	46	4.46	50
	M10	707F10	13.0	25	25	10.5	17.0	12.00	12.0	48	4.62	50
	M12	707F12	13.0	25	25	13.0	17.0	13.00	13.0	50	4.71	50
	M14	707F14	13.0	25	25	15.0	17.0	14.50	14.5	52	4.87	25
	M16	707F16	13.0	25	25	17.0	17.0	16.00	16.0	54	5.85	25
95	M8	708F8	14.5	26	28	8.5	19.0	12.00	12.0	52	6.35	25
	M10	708F10	14.5	26	28	10.5	19.0	12.00	12.0	52	6.23	50
	M12	708F12	14.5	26	28	13.0	19.0	13.00	13.0	53	6.31	50
	M14	708F14	14.5	26	28	15.0	19.0	14.50	14.5	55	6.46	25
	M16	708F16	14.5	26	28	17.0	19.0	16.00	16.0	56	6.56	50
120	M10	709F10	16.2	30	30	10.5	21.0	14.00	14.0	57	8.31	50
	M12	709F12	16.2	30	30	13.0	21.0	15.00	15.0	58	8.39	50
	M14	709F14	16.2	30	30	15.0	21.0	15.00	15.0	58	8.06	25
	M16	709F16	16.2	30	30	17.0	21.0	16.00	16.0	59	8.17	50
	M20	709F20	16.2	30	36	21.0	21.0	22.00	22.0	66	9.56	25
150	M10	710F10	18.0	32	34	10.5	23.0	15.00	16.0	64	10.91	10
	M12	710F12	18.0	32	34	13.0	23.0	16.00	17.0	65	10.89	25
	M14	710F14	18.0	32	34	15.0	23.0	18.00	19.0	67	11.42	10
	M16	710F16	18.0	32	34	17.0	23.0	19.00	20.0	68	11.30	10
	M20	710F20	18.0	32	40	21.0	23.0	21.00	22.0	70	11.36	10
185	M12	711F12	20.6	35	39	13.0	26.0	21.50	19.0	72	15.40	10
	M14	711F14	20.6	35	39	15.0	26.0	21.50	19.0	72	15.20	10
	M16	711F16	20.6	35	39	17.0	26.0	21.50	19.0	72	15.00	25
	M20	711F20	20.6	35	39	21.0	26.0	21.50	19.0	72	14.20	10
240	M10	712F10	23.1	44	41	10.5	28.0	16.00	17.0	80	16.50	10
	M12	712F12	23.1	44	41	13.0	28.0	16.00	17.0	80	16.30	10
	M14	712F14	23.1	44	41	15.0	28.0	19.00	20.0	83	16.80	10
	M16	712F16	23.1	44	41	17.0	28.0	19.00	20.0	83	16.71	25
	M20	712F20	23.1	44	41	21.0	28.0	21.00	22.0	85	17.12	10
300	M12	713F12	26.1	44	47	13.0	32.0	19.00	22.0	96	25.60	5
	M14	713F14	26.1	44	47	15.0	32.0	19.00	22.0	96	26.56	5
	M16	713F16	26.1	44	47	17.0	32.0	19.00	22.0	96	25.60	5
	M20	713F20	26.1	44	47	21.0	32.0	22.00	22.0	96	26.24	5



Angled tubular cable lugs, Cu, 90° angled, F-series



- ▶ For fine and superfine stranded round conductors, e.g. to DIN EN 60228 Cl. 5 and 6
- ▶ Tube dimension adjusted for fine and superfine stranded conductors
- ▶ Special wide opening for the easy entry of fine conductors
- ▶ Flat contact surface by special angle pressing technology

Characteristics

- Annealed material optimises material and crimping properties
- Tube dimensions suitable for fine stranded conductors
- Flat contact surface and internal chamfer for simple cable insertion

Material

- Copper (EN13600)

Surface

- Tin-plated to protect against corrosion

Technical instructions

- Tool: see page 42

Additional information

- Also available as featured article 45° angled, part number appendix „45“
- Also available as featured article with inspection hole, part number appendix „MS“
- 90° angled version: 10 - 240 mm² UL-tested

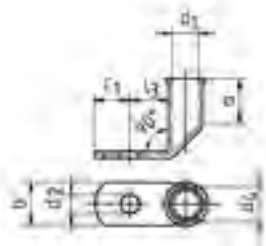

Nominal cross section mm ²	Size of bolt dia.	Part No.	Dimension mm							Weight/ 100 pcs. ~ kg	Packing unit/pcs
			d1	a	b	d2	d4	c1	l3		
10	M5	742F5	5.5	14	12	5.3	8.0	6.25	7.5	0.80	50
	M6	742F6	5.5	14	12	6.5	8.0	6.25	7.5	0.78	50
	M8	742F8	5.5	14	16	8.5	8.0	9.00	9.5	0.84	50
	M10	742F10	5.5	14	16	10.5	8.0	10.50	12.0	0.88	50
	M12	742F12	5.5	14	19	13.0	8.0	12.00	13.0	0.90	50
16	M5	743F5	6.6	15	13	5.3	9.5	6.25	7.5	1.12	50
	M6	743F6	6.6	15	13	6.5	9.5	6.25	7.5	1.12	50
	M8	743F8	6.6	15	16	8.5	9.5	10.00	10.0	1.30	50
	M10	743F10	6.6	15	17	10.5	9.5	12.00	12.0	1.38	50
	M12	743F12	6.6	15	19	13.0	9.5	13.00	13.0	1.34	50
25	M5	744F5	7.9	17	15	5.3	11.0	7.50	7.5	1.52	25
	M6	744F6	7.9	17	15	6.5	11.0	7.50	7.5	1.54	25
	M8	744F8	7.9	17	17	8.5	11.0	10.00	10.0	1.80	25
	M10	744F10	7.9	17	17	10.5	11.0	12.00	12.0	1.79	25
	M12	744F12	7.9	17	19	13.0	11.0	13.00	13.0	1.76	25
35	M6	745F6	9.2	19	17	6.5	12.5	7.50	7.5	2.02	25
	M8	745F8	9.2	19	18	8.5	12.5	10.00	10.0	2.18	25
	M10	745F10	9.2	19	18	10.5	12.5	12.00	12.0	2.30	25
	M12	745F12	9.2	19	19	13.0	12.5	13.00	13.0	2.26	25
	M14	745F14	9.2	19	21	15.0	12.5	14.50	14.5	2.65	25
50	M6	746F6	11.0	21	21	6.5	15.0	10.00	10.0	3.75	25
	M8	746F8	11.0	21	21	8.5	15.0	10.00	10.0	3.57	25
	M10	746F10	11.0	21	21	10.5	15.0	12.00	12.0	3.83	25
	M12	746F12	11.0	21	21	13.0	15.0	13.00	13.0	3.74	25
	M14	746F14	11.0	21	23	15.0	15.0	14.50	14.5	4.20	25
	M16	746F16	11.0	21	28	17.0	15.0	16.00	16.0	4.35	25

See next page



Angled tubular cable lugs, Cu, 90° angled, F-series

Nominal cross section mm ²	Size of bolt dia.	Part No.	Dimension mm						Weight/ 100 pcs. ~ kg	Packing unit/pcs	
			d1	a	b	d2	d4	c1			l3
70	M8	747F8	13.0	25	25	8.5	17.0	10.00	10.0	4.83	25
	M10	747F10	13.0	25	25	11.0	17.0	12.00	12.0	5.18	25
	M12	747F12	13.0	25	25	13.0	17.0	13.00	13.0	5.16	25
	M14	747F14	13.0	25	25	15.0	17.0	14.50	14.5	5.38	25
	M16	747F16	13.0	25	25	17.0	17.0	16.00	16.0	6.50	25
	M8	748F8	14.5	26	28	8.5	19.0	12.00	12.0	6.66	25
95	M10	748F10	14.5	26	28	11.0	19.0	12.00	12.0	6.04	25
	M12	748F12	14.5	26	28	13.0	19.0	13.00	13.0	6.58	25
	M14	748F14	14.5	26	28	15.0	19.0	14.50	14.5	7.24	25
	M16	748F16	14.5	26	28	17.0	19.0	16.00	16.0	7.34	25
120	M10	749F10	16.2	30	30	11.0	21.0	14.00	14.0	8.76	10
	M12	749F12	16.2	30	30	13.0	21.0	15.00	15.0	8.76	10
	M14	749F14	16.2	30	30	15.0	21.0	15.00	15.0	9.15	10
	M16	749F16	16.2	30	30	17.0	21.0	16.00	16.0	8.54	10
	M20	749F20	16.2	30	36	21.0	21.0	22.00	22.0	9.60	10
150	M10	750F10	18.0	32	34	11.0	23.0	15.00	16.0	11.54	10
	M12	750F12	18.0	32	34	13.0	23.0	16.00	18.0	11.58	10
	M14	750F14	18.0	32	34	15.0	23.0	18.00	19.0	11.90	10
	M16	750F16	18.0	32	34	17.0	23.0	19.00	20.0	11.80	10
	M20	750F20	18.0	32	40	21.0	23.0	21.00	22.0	12.00	10
185	M12	751F12	20.6	35	39	13.0	26.0	21.50	19.0	16.36	10
	M14	751F14	20.6	35	39	15.0	26.0	21.50	19.0	16.20	10
	M16	751F16	20.6	35	39	17.0	26.0	21.50	19.0	15.36	10
	M20	751F20	20.6	35	39	21.0	26.0	21.50	19.0	15.80	10
240	M16	752F16	23.1	44	41	17.0	28.0	19.00	20.0	17.80	5



Butt connectors, Cu, F-series



- ▶ For fine and superfine stranded round conductors, e.g. to DIN EN 60228 Cl. 5 and 6
- ▶ Pipe dimension adjusted for fine and superfine stranded conductors
- ▶ Special wide opening for the easy entry of fine conductors

Characteristics

- Simple and safe processing due to butt mark
- Annealed material optimises material and crimping properties
- Simple cable entry due to internal chamfer

Material

- Copper (EN13600)

Surface

- Tin-plated to protect against corrosion

Technical instructions

- Tool: see page 42

Nominal cross section mm ²	Part No.	Dimension mm			Weight/ 100 pcs. ~ kg	Packing unit/pcs
		d1	d4	l		
10	722F	5.5	8.0	38	0.90	100
16	723F	6.6	9.5	38	1.25	100
25	724F	7.9	11.0	38	1.56	50
35	725F	9.2	12.5	45	2.19	50
50	726F	11.0	15.0	45	3.37	50
70	727F	13.0	17.0	54	4.65	50
95	728F	14.5	19.0	56	6.05	25
120	729F	16.2	21.0	60	7.58	25
150	730F	18.0	23.0	68	9.83	10
185	731F	20.6	26.0	75	13.30	10

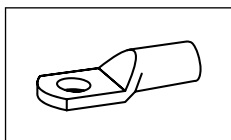

Tool application chart

Tubular cable lugs, butt connectors, parallel connectors and T-connectors „standard type“ and tubular cable lugs for switchgear connections made from Cu
Part 1 of 2

Tool type	Crimping range corresponds to nominal cross-section mm ²	Crimping Tool		Catalogue page		Crimp profile
		Part No.	Crimping head / adapter	Crimping Tool	Crimping die	
Mechanical crimping tools	0.75-16	K2		229		
	1-4	K511		239		
	6-50	K5		231		
		K05		235		
	6+10	K512		239		
	10-25	K04		234		
	10-120	K06		236		
	16-95	K95		230		
		TK95		231		
	25-150	K09		238		
	50-120	K6		232		
	120-240	K7		233		
	185-400	K07		232		
Mechanical, electrical, pneumatic crimping tools with interchangeable dies / heads	0.75-2.5	KP1	+KP232	240		
		KP1L	+KP232	240		
	0.75-10	K50		244	326	
		EK50ML		254	326	
	4-10	KP1	+KP242	240		
		KP1L	+KP242	240		
	6-150	K354		246	328	
	6-185	K18		248	337	
	6-300	K22		250	341	
	Hand hydraulic crimping tools	6-185	HK6018		292	337
HK60UNV			+UA18	473	337	
6-300		HK6022		294	341	
		HK60UNV	+UA22	473	341	
10-240		HK60VP		296		
16-300		HK60VPFT		297		
16-400		HK12030		298	347	
		HK12042		300	347	
		HK120U		302	347	
Battery powered crimping tools	0.75-2.5	EKP1ML	+KP232	260		
	0.75-10	EK1550ML		258	326	
	4-10	EKP1ML	+KP242	260		
	6-150	EK354ML		262	328	
		EK354		266	328	
	6-185	EK5018		270	337	
		EK60UNV	+UA18	476	337	
		EKM60UNV	+UA18	475	337	
	6-240	EK505		268	333	

See next page

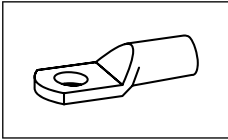

Tool application chart

Tubular cable lugs, butt connectors, parallel connectors and T-connectors „standard type“ and tubular cable lugs for switchgear connections made from Cu
Part 2 of 2

Tool type	Crimping range corresponds to nominal cross-section mm ²	Crimping Tool		Catalogue page		Crimp profile
		Part No.	Crimping head / adapter	Crimping Tool	Crimping die	
Battery powered crimping tools	6-300	EK6022		274	341	⬡
		EKM6022		272	341	⬡
		EK60UNV	+UA22	476	341	⬡
		EKM60UNV	+UA22	475	341	⬡
	10-240	EK60VP		276		⬢
		EKM60ID		278		⬢
	16-300	EK60VPFT		277		⬢
	16-400	EK12032		280	347	⬡
		EK12042		282	347	⬡
		EK120U		284	347	⬡
		EK135FT	+UA12T	286	347	⬡
		EK120UNV	+UA15T	477	347	⬡
	35-500	EK120ID		279		⬢
	500-630	EK135FT		286	352	⬡
Hydraulic crimping systems	6-185	THK18		306	337	⬡
	6-300	THK22		308	341	⬡
	16-400	HK122EL380		322	347	⬡
		HK252		320	353	⬡
HK252EL380			322	353	⬡	
Hydraulic crimping heads	6-185	PK18		306	337	⬡
		PK60UNV	+UA18	474	337	⬡
	6-300	PK22		308	341	⬡
		PK60UNV	+UA22	474	341	⬡
	10-240	PK60VP		310		⬢
		PK60ID		311		⬢
	16-300	PK60VPFT		310		⬢
	16-400	PK12042		312	347	⬡
		PK120U		314	347	⬡
		PK252		316	353	⬢

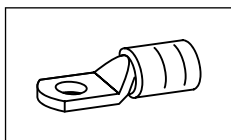

Tool application chart

Insulated tubular cable lugs and butt connectors „standard type“

Tool type	Crimping range corresponds to nominal cross-section mm ²	Crimping Tool		Catalogue page		Crimp profile
		Part No.	Crimping head / adapter	Crimping Tool	Crimping die	
Mechanical, electrical, pneumatic crimping tools with interchangeable dies / heads	10-70	K354		246	328	○
	10-95	K18		248	337	○
	10-150	K22		250	341	○
Hand hydraulic crimping tools	10-95	HK6018		292	337	○
		HK60UNV	+UA18	473	337	○
	10-150	HK6022		294	341	○
		HK60UNV	+UA22	473	341	○
		HK12030		298	347	○
		HK12042		300	347	○
		HK120U		302	347	○
Battery powered crimping tools	10-70	EK354ML		262	328	○
		EK354		266	328	○
	10-95	EK5018		270	337	○
		EK505		268	333	○
		EK60UNV	+UA18	476	337	○
		EKM60UNV	+UA18	475	337	○
		EK12032		280	347	○
	10-150	EK6022		274	341	○
		EKM6022		272	341	○
		EK60UNV	+UA22	476	341	○
		EKM60UNV	+UA22	475	341	○
		EK12042		282	347	○
		EK120U		284	347	○
		EK135FT	+UA15T	286	347	○
		EK120UNV	+UA12T	477	347	○
Hydraulic crimping systems	10-95	THK18		306	337	○
	10-150	THK22		308	341	○
		HK122EL380		322	347	○
		HK252EL380		323	353	○
		HK252		320	353	○
Hydraulic crimping heads	10-95	PK18		306	337	○
		PK60UNV	+UA18	474	337	○
	10-150	PK22		308	341	○
		PK60UNV	+UA22	474	341	○
		PK12042		312	347	○
		PK120U		314	347	○
		PK252		316	353	○

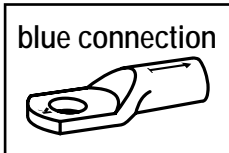

Tool application chart

Tubular cable lugs and butt connectors blue connection[®]

Tool type	Crimping range corresponds to nominal cross-section mm ²	Crimping Tool		Catalogue page		Crimp profile
		Part No.	Crimping head / adapter	Crimping Tool	Crimping die	
Mechanical crimping tools	6-50	K05BC		234		⬡
	6-300	K22		250	342	⬡
	10-120	K06BC		236		⬡
	25-150	K09BC		237		⬡
Mechanical, electrical, pneumatic crimping tools with interchangeable dies / heads	6-150	K354		246	329	⬡
Hand hydraulic crimping tools	6-240	HK60UNV	+UA5	473	333	⬡
	6-300	HK6022		294	342	⬡
		HK60UNV	+UA22	473	342	⬡
Battery powered crimping tools	6-150	EK354ML		262	329	⬡
		EK354		266	329	⬡
	6-240	EK505		268	333	⬡
		EKM60UNV	+UA5	475	333	⬡
		EK60UNV	+UA5	475	333	⬡
	6-300	EK6022		274	342	⬡
		EKM6022		272	342	⬡
		EKM60UNV	+UA22	475	342	⬡
EK60UNV		+UA22	476	342	⬡	
Hydraulic crimping systems	6-300	THK22		308	342	⬡
	16-400	HK122EL380		322		⬡
Hydraulic crimping heads	6-300	PK22		308	342	⬡
		PK60UNV	+UA22	474	342	⬡

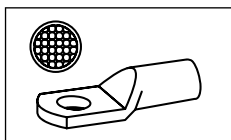

Tool application chart

Tubular cable lugs and butt connectors for fine stranded conductors

Part 1 of 2

Tool type	Crimping range corresponds to nominal cross-section mm ²	Crimping Tool		Catalogue page		Crimp profile
		Part No.	Crimping head / adapter	Crimping Tool	Crimping die	
Mechanical crimping tools	6-50	K5		231		
	16-95	K95		230		
		TK95		231		
	50-120	K6		232		
	120-240	K7		233		
	185-400	K07		232		
Mechanical, electrical, pneumatic crimping tools with interchangeable dies / heads	10-35	K354		246	329	
	10-50	K18		248	337	
	10-70	K22		250	342	
Hand hydraulic crimping tools	10-50	HK6018		292	337	
		HK60UNV	+UA18	473	337	
	10-70	HK6022		294	342	
		HK60UNV	+UA22	473	342	
	10-240	HK60VP		296		
	16-150	HK12030		298	348	
		HK12042		300	348	
		HK120U		302	348	
	16-300	HK60VPFT		297		
	Battery powered crimping tools	10-35	EK354ML		262	329
EK354				266	329	
10-50		EK505		268	334	
		EK5018		270	337	
		EK60UNV	+UA18	476	337	
		EKM60UNV	+UA18	475	337	
10-70		EK6022		274	342	
		EKM6022		272	342	
		EK60UNV	+UA22	476	342	
		EKM60UNV	+UA22	475	342	
10-240		EK60VP		276		
		EKM60ID		278		
16-150		EK12032		280	348	
		EK12042		282	348	
		EK120U		284	348	
		EK135FT	+UA15T	286	348	
		EK120UNV	+UA12T	322	348	
16-300	EK60VPFT		277			
35-500	EK120ID		279			
Hydraulic crimping systems	10-50	THK18		306	337	
	10-70	THK22		308	342	
	16-300	HK252		320	354	
		HK252EL380		323	354	

See next page

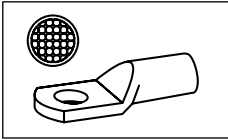

Tool application chart

Tubular cable lugs and butt connectors for fine stranded conductors

Part 2 of 2

Tool type	Crimping range corresponds to nominal cross-section mm ²	Crimping Tool		Catalogue page		Crimp profile
		Part No.	Crimping head / adapter	Crimping Tool	Crimping die	
Hydraulic crimping heads	10-50	PK18		306	337	
		PK60UNV	+UA18	474	337	
	10-70	PK22		308	342	
		PK60UNV	+UA22	474	342	
	10-240	PK60VP		310		
		PK60ID		311		
	16-150	PK12042		312	348	
		PK120U		314	348	
	16-300	PK60VPFT		310		
		PK252		316	354	

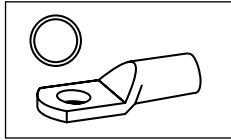

Tool application chart

Tubular cable lugs and butt connectors for solid conductors

Tool type	Crimping range corresponds to nominal cross-section mm ²	Crimping Tool		Catalogue page		Crimp profile
		Part No.	Crimping head / adapter	Crimping Tool	Crimping die	
Mechanical crimping tools	0.75-16	K02		229		
	1.5-4	K93		228		
	6-10	K94		228		
	25-50*	K05		235		
Mechanical, electrical, pneumatic crimping tools with interchangeable dies / heads	1.5-10	K50		244	326	
		EK50ML		254	326	
	1.5-16	K354		246	329	
		K18		248	338	
		K22		250	342	
Hand hydraulic crimping tools	1.5-16	HK6018		292	338	
		HK60UNV	+UA18	473	338	
		HK6022		294	342	
		HK60UNV	+UA22	473	342	
Battery powered crimping tools	1.5-10	EK1550ML		258	326	
	1.5-16	EK354ML		262	329	
		EK354		266	329	
		EK5018		270	338	
		EK60UNV	+UA18	476	338	
		EKM60UNV	+UA18	475	338	
		EK6022		274	342	
		EKM6022		272	342	
		EK60UNV	+UA22	476	342	
		EKM60UNV	+UA22	475	342	
		Hydraulic crimping systems	1.5-16	THK18		306
THK22				308	342	
Hydraulic crimping heads	1.5-16	PK18		306	338	
		PK60UNV	+UA18	474	338	
		PK22		308	342	
		PK60UNV	+UA22	474	342	

*For cross-sections 25 + 35 mm² use the die size 25 mm².
For cross-section 50 mm² use the die size 35 mm².
We recommend 2 crimps on each side





THE RESISTANT – TUBULAR CABLE LUGS AND CONNECTORS, NICKEL OR STAINLESS STEEL

We also develop for use in tough conditions. Our tubular cable lugs and connectors made from nickel and stainless steel are a cut above: withstanding temperatures of up to 650 °C, our Klauke products have without doubt developed to meet the requirements of the chemical industry, the foodstuff sector and foodstuff industry. You can also rely on our high-quality products for special applications. We know what we are doing.



In brief

- ▶ Tough to 650 °C
- ▶ Suitable for the chemical and foodstuff industry sectors, for instance
- ▶ Suitable even for aggressive environments, such as contact with salt water



► When things get hot: Nickel cable lugs

Nickel cable lugs are especially suitable for use in applications at high temperatures of up to 650 °C. Thanks to their high resilience they no longer need to be frequently replaced at connections exposed to heat.

- High-quality nickel
- Heat-resistant to 650 °C
- No constant replacement of the cable lug at hot locations



► Safe in aggressive environments with stainless steel

High-quality stainless steel ensures extra resilience, especially in aggressive environments. The resistance is retained.

- High-quality V2A and V4A stainless steel
- Acid resistant
- Can be used at temperatures to 400 °C
- V2A stainless steel for the chemical and foodstuff sectors and salt water applications
- V4A stainless steel in chlorinated environments such as swimming pools, for instance



Tubular cable lugs, stainless steel

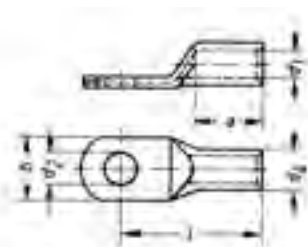

- ▶ For multi-stranded round conductors, e.g. to DIN EN 60228 Cl. 2
- ▶ For pre-rounded stranded sector shaped conductors
- ▶ Ideal for aggressive environmental conditions, acid and rust-resistant
- ▶ Heat resistant up to 400 °C

Characteristics

- Flat contact surface by special pressing technology
- Simple and safe connection due to flat contact surfaces and internal chamfer

Material

- V2A

Technical instructions

- Tool: see page 53

Additional information

- Also available as featured article in stainless steel V4A

Nominal cross section mm ²	Size of bolt dia.	Part No.	Dimension mm						Weight/ 100 pcs. ~ kg	Packing unit/ pcs
			d1	a	b	d2	d4	l		
0.5-1	M4	79V4	1.6	6	6.5	4.3	3.2	13	0.080	100
	M5	79V5	1.6	6	7.5	5.3	3.2	14	0.080	100
1.5-2.5	M4	80V4	3.0	8	9.0	4.3	5.0	17	0.260	100
	M5	80V5	3.0	8	9.0	5.5	5.0	17	0.190	100
	M6	80V6	3.0	8	9.5	6.5	5.0	19	0.215	100
4-6	M4	81V4	4.0	9	9.0	4.3	6.0	18	0.260	100
	M5	81V5	4.0	9	9.5	5.5	6.0	19	0.280	100
	M6	81V6	4.0	9	10.0	6.5	6.0	19	0.280	100
10	M5	82V5	5.0	10	12.5	5.5	8.0	22	0.710	100
	M6	82V6	5.0	10	12.5	6.5	8.0	22	0.780	100
	M8	82V8	5.0	10	15.0	8.5	8.0	25	0.780	100
16	M5	83V5	6.0	13	12.0	5.5	8.0	28	0.500	50
	M6	83V6	6.0	13	12.0	6.5	8.0	28	0.550	50
	M8	83V8	6.0	13	15.0	8.5	8.0	29	0.600	50
25	M6	84V6	7.0	15	14.0	6.5	10.0	30	1.210	50
	M8	84V8	7.0	15	16.0	8.5	10.0	32	1.850	50
35	M6	85V6	9.0	17	17.0	6.5	12.0	32	1.600	50
	M8	85V8	9.0	17	17.0	8.5	12.0	35	1.850	50
50	M6	86V6	10.0	19	20.0	6.5	14.0	37	2.800	50
	M8	86V8	10.0	19	20.0	8.5	14.0	37	2.600	50
	M10	86V10	10.0	19	20.0	10.5	14.0	39	2.800	50
70	M12	86V12	10.0	19	20.0	13.0	14.0	43	2.960	50
	M8	87V8	12.0	21	23.0	8.5	16.0	43	3.650	25
	M10	87V10	12.0	21	23.0	10.5	16.0	44	3.930	25
	M12	87V12	12.0	21	23.0	13.0	16.0	46	3.850	25
95	M16	87V16	12.0	21	26.0	17.0	16.0	46	3.960	25
	M8	88V8	14.0	25	26.0	8.5	18.0	48	4.650	25
	M10	88V10	14.0	25	26.0	10.5	18.0	48	5.610	25
	M12	88V12	14.0	25	26.0	13.0	18.0	49	5.540	25



Butt connectors, stainless steel



- ▶ For multi-stranded round conductors, e.g. to DIN EN 60228 Cl. 2
- ▶ Ideal for aggressive environmental conditions, acid and rust-resistant
- ▶ Heat resistant up to 400 °C



Characteristics

- Simple and safe processing due to butt mark
- Simple cable entry due to internal chamfer



Material

- V2A



Technical instructions

- Tool: see page 53



Additional information

- Also available as featured article in stainless steel V4A



Nominal cross section mm ²	Part No.	Dimension mm			Weight/ 100 pcs. ~ kg	Packing unit/pcs
		d1	d4	l		
0.5-1	79R	1.6	3.2	25	0.135	50
1.5-2.5	80R	3.0	5.0	25	0.250	50
4-6	81R	4.0	6.0	25	0.325	50
10	82R	5.0	8.0	25	0.360	50
16	83R	6.0	8.0	30	0.510	50
25	84R	7.0	10.0	35	1.100	25
35	85R	9.0	12.0	40	1.560	25
50	86R	10.0	14.0	45	2.670	25
70	87R	12.0	16.0	50	3.400	25
95	88R	14.0	18.0	55	4.300	25



Tubular cable lug, Ni

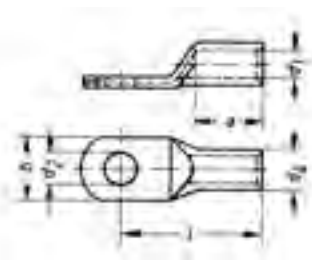

- ▶ For multi-stranded round conductors, e.g. to DIN EN 60228 Cl. 2
- ▶ Suitable for high temperatures up to 650 °C



Characteristics

- Simple and safe connection due to flat contact surfaces and internal chamfer



Material

- High-grade nickel



Technical instructions

- Tool: see page 53



Nominal cross section mm ²	Size of bolt dia.	Part No.	Dimension mm						Weight/ 100 pcs. ~ kg	Packing unit/ pcs
			d1	a	b	d2	d4	l		
0.5-1	M4	56N4	1.6	6	6.5	4.3	3.2	13	0.080	100
	M5	56N5	1.6	6	7.5	5.3	3.2	14	0.080	100
1.5-2.5	M4	57N4	2.3	6	7.0	4.3	3.9	13	0.105	100
	M5	57N5	2.3	6	7.5	5.3	3.9	14	0.105	100
	M6	57N6	2.3	6	9.5	6.5	3.9	16	0.130	100
4-6	M4	58N4	3.6	9	9.5	4.3	5.6	18	0.275	100
	M5	58N5	3.6	9	9.5	5.3	5.6	19	0.275	100
	M6	58N6	3.6	9	9.5	6.5	5.6	19	0.260	100
10	M5	59N5	4.5	10	12.0	5.5	6.5	21	0.340	100
	M6	59N6	4.5	10	12.0	6.5	6.5	22	0.360	100
16	M5	60N5	5.5	13	12.0	5.5	7.5	26	0.470	100
	M6	60N6	5.5	13	12.0	6.5	7.5	27	0.480	100
	M8	60N8	5.5	13	13.5	8.5	7.5	29	0.560	100
25	M6	61N6	7.0	15	14.0	6.5	10.0	30	1.200	50
	M8	61N8	7.0	15	16.0	8.5	10.0	32	1.320	50
35	M6	62N6	8.5	17	17.0	6.5	12.0	32	1.850	50
	M8	62N8	8.5	17	17.0	8.5	12.0	34	2.000	50
50	M8	63N8	10.0	19	20.0	8.5	14.0	37	2.900	50
	M10	63N10	10.0	19	20.0	10.5	14.0	39	3.100	50
70	M10	64N10	12.0	21	23.0	10.5	16.5	44	4.600	25
	M12	64N12	12.0	21	23.0	13.0	16.5	46	4.660	25
95	M10	65N10	13.5	25	26.0	10.5	18.0	48	5.550	25
	M12	65N12	13.5	25	26.0	13.0	18.0	49	5.600	25



Tubular cable lugs, Cu, fork type

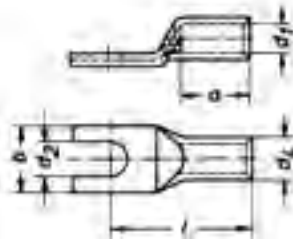

- ▶ For multi-stranded round conductors, e.g. to DIN EN 60228 Cl. 2
- ▶ Suitable for high temperatures up to 650 °C
- ▶ Simple fork-type mounting



Characteristics

- Simple and safe connection due to flat contact surfaces and internal chamfer



Material

- High-grade nickel



Technical instructions

- Tool: see page 53



Nominal cross section mm ²	Size of bolt dia.	Part No.	Dimension mm						Weight/ 100 pcs. ~ kg	Packing unit/ pcs
			d1	a	b	d2	d4	l		
0.5-1	M4	56C4	1.6	6	6.5	4.3	3.2	13	0.070	50
	M5	56C5	1.6	6	7.5	5.3	3.2	14	0.075	50
1.5-2.5	M4	57C4	2.3	6	7.0	4.3	3.9	13	0.095	50
	M5	57C5	2.3	6	7.5	5.3	3.9	14	0.095	50
	M6	57C6	2.3	6	9.5	6.5	3.9	16	0.110	50
4-6	M4	58C4	3.6	9	9.5	4.3	5.6	18	0.250	50
	M5	58C5	3.6	9	9.5	5.3	5.6	19	0.255	50
	M6	58C6	3.6	9	9.5	6.5	5.6	19	0.235	50
10	M5	59C5	4.5	10	12.0	5.5	6.5	21	0.320	50
	M6	59C6	4.5	10	12.0	6.5	6.5	22	0.340	50
16	M5	60C5	5.5	13	12.0	5.5	7.5	26	0.440	50
	M6	60C6	5.5	13	12.0	6.5	7.5	27	0.450	50
	M8	60C8	5.5	13	13.5	8.5	7.5	29	0.520	50



Butt connectors, Ni



- ▶ For multi-stranded round conductors, e.g. to DIN EN 60228 Cl. 2
- ▶ Suitable for high temperatures to 650 °C



Characteristics

- Simple and safe processing due to butt mark
- Simple cable entry due to internal chamfer



Material

- High-grade nickel



Technical instructions

- Tool: see page 53



Nominal cross section mm ²	Part No.	Dimension mm			Weight/ 100 pcs. ~ kg	Packing unit/pcs
		d1	d4	l		
0.5-1	62R	1.6	3.2	25	0.135	50
1.5-2.5	63R	2.3	3.9	25	0.170	50
4-6	64R	3.6	5.6	25	0.325	50
10	65R	4.5	6.5	25	0.360	50
16	66R	5.5	7.5	30	0.510	50

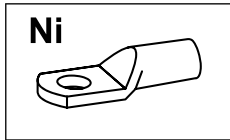
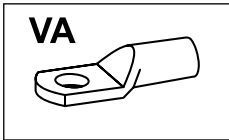

Tool application chart

Tubular cable lugs and butt connectors made from stainless steel or nickel

Tool type	Crimping range corresponds to nominal cross-section mm ²	Crimping Tool		Catalogue page		Crimp profile
		Part No.	Crimping head / adapter	Crimping Tool	Crimping die	
Mechanical crimping tools	0.5-6	K25		230		
Mechanical, electrical, pneumatic crimping tools with interchangeable dies / heads	0.5-16	K354		246	329	
	10-50	K22		250	342	
Hand hydraulic crimping tools	10-50	HK6022		294	342	
		HK6022	+UA22	473	342	
	70-95	HK12030		298	348	
		HK12042		300	348	
Battery powered crimping tools	0.5-16	EK354ML		262	329	
		EK354		266	342	
	10-50	EKM6022		272	342	
		EK6022		274	342	
		EK60UNV	+UA22	476	342	
		EKM60UNV	+UA22	475	342	
	70-95	EK12032		280	348	
		EK12042		282	348	
		EK120U		284	348	
		EK120UNV	+UA12T	477	348	
		EK135FT	+UA15T	286	348	
Hydraulic crimping systems	10-50	THK22		308	342	
Hydraulic crimping heads	10-50	PK22		308	342	
		PK60UNV	+UA22	474	342	
	70-95	PK12042		312	348	
		PK120U		314	348	

CONFORMITY - COPPER COMPRESSION CABLE LUGS AND CONNECTORS TO DIN

Klauke products conform not only to its own standards. But also to DIN standards with strict standardised dimensions. Our compression cable lugs and connectors range to 1000 mm² nominal cross-section, with standardised designations and markings. We have the quality certified by the IEC test, including our special versions.



In brief

- ▶ Standardised sizes even for special versions
- ▶ Clear markings for standardised processing
- ▶ For all conductor classes to DIN EN 60228



▶ Tested and certified for safety

Our DIN cable lugs and connectors are strictly manufactured to standard. In addition, the test suggested in the standard has been passed with ease.

- Simple processing with DIN system
- Safety through standardised tests
- For all conductor classes to DIN EN 60228 and copper wires to DIN 46267-1



▶ Every version standardised

We offer cable lugs with tube dimension to DIN in numerous different forms and versions. If there happens to be no suitable connector for you, we will of course make you one to suit your needs.

- Flexible thanks to numerous versions
- Various surfaces available
- Many special versions based on the DIN standard available
- Manufactured to suit your particular requirements

▶ Clear markings

Where simplicity and safety are key: Every cable lug to DIN comes with the appropriate crimping instruction. Readily visible markings indicate the crimping location required to work in compliance with the standard. Code numbers on the dies and cable lugs show the correct crimp at a glance.

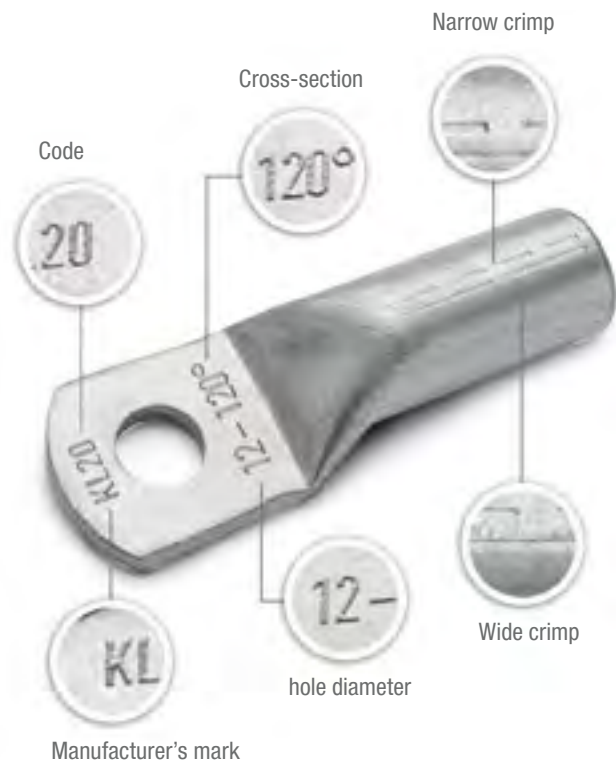



Compression cable lugs to DIN, Cu

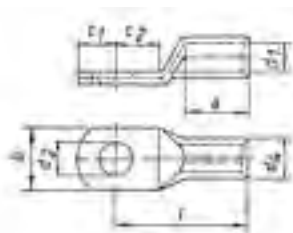

- ▶ For round conductors, e.g. to DIN EN 60228 Cl. 1, 2, 5 and 6
- ▶ For non-tension copper cables, e.g. to DIN 48201
- ▶ For pre-rounded multi-stranded sector shaped conductors
- ▶ With code number for clear tool assignment
- ▶ To DIN 46235

Characteristics

- Easy to process due to crimp markings
- Annealed material optimises material and crimping properties
- Simple and safe connection due to flat contact surfaces and internal chamfer

Material

- Copper (EN13600)

Surface

- Tin-plated to protect against corrosion

Technical instructions

- Tool: see page 69
- Sleeves for compacted conductors and sleeves for 3-core and 4-core cables, see chapter „Sleeves for compacted conductors and sector shaped conductors - Cu“

Additional information

- Part Number appendix for bright version „BK“
- Item in barrier sealed design upon request
- 10 - 800 mm² IEC-tested
- * = not standardised

Nominal cross section mm ²	Size of bolt diameter	Part No.	Hint	Code	Dimension mm								Weight/ 100 pcs. ~ kg	Packing unit/pcs
					a	b	d1	d2	d4	c1	c2	l		
6	M 5	101R5		5	10	8.5	3.8	5.3	5.5	6.5	7.5	24	0.24	100
	M 6	101R6		5	10	8.5	3.8	6.4	5.5	7.5	8.0	24	0.30	100
	M 8	101R8	*	5	10	13.0	3.8	8.4	5.5	10.0	10.0	24	0.34	100
10	M 5	102R5		6	10	9.0	4.5	5.3	6.0	7.0	8.5	27	0.37	100
	M 6	102R6		6	10	9.0	4.5	6.4	6.0	7.5	8.5	27	0.36	100
	M 8	102R8	*	6	10	13.0	4.5	8.4	6.0	10.0	10.0	27	0.38	100
16	M 6	103R6		8	20	13.0	5.5	6.4	8.5	7.5	8.0	36	1.19	100
	M 8	103R8		8	20	13.0	5.5	8.4	8.5	10.0	10.0	36	1.22	100
	M 10	103R10		8	20	17.0	5.5	10.5	8.5	12.0	12.0	36	1.30	100
	M 12	103R12	*	8	20	18.0	5.5	13.0	8.5	13.0	13.0	36	1.27	100
25	M 6	104R6		10	20	14.0	7.0	6.4	10.0	7.5	8.0	38	1.51	50
	M 8	104R8		10	20	16.0	7.0	8.4	10.0	10.0	10.0	38	1.54	50
	M 10	104R10		10	20	17.0	7.0	10.5	10.0	12.0	12.0	38	1.62	50
	M 12	104R12		10	20	19.0	7.0	13.0	10.0	13.0	13.0	38	1.66	25
35	M 6	105R6	*	12	20	17.0	8.2	6.4	12.5	7.5	8.0	42	2.77	50
	M 8	105R8		12	20	17.0	8.2	8.4	12.5	10.0	10.0	42	2.85	50
	M 10	105R10		12	20	19.0	8.2	10.5	12.5	12.0	12.0	42	2.84	50
	M 12	105R12		12	20	21.0	8.2	13.0	12.5	13.0	13.0	42	2.79	50
	M 14	105R14	*	12	20	21.0	8.2	15.0	12.5	14.5	14.5	42	2.70	25

see next page



Compression cable lugs to DIN, Cu

Nominal cross section mm ²	Size of bolt diameter	Part No.	Hint	Code	Dimension mm							Weight/100 pcs. ~ kg	Packing unit/pcs	
					a	b	d1	d2	d4	c1	c2			l
50	M 8	106R8		14	28	20.0	10.0	8.4	14.5	10.0	10.0	52	4.46	50
	M 10	106R10		14	28	22.0	10.0	10.5	14.5	12.0	12.0	52	4.48	50
	M 12	106R12		14	28	24.0	10.0	13.0	14.5	13.0	13.0	52	4.40	50
	M 14	106R14	*	14	28	24.0	10.0	15.0	14.5	14.5	14.5	52	4.30	25
	M 16	106R16		14	28	28.0	10.0	17.0	14.5	16.0	16.0	52	4.57	25
70	M 8	107R8		16	28	24.0	11.5	8.4	16.5	10.0	10.0	55	5.92	50
	M 10	107R10		16	28	24.0	11.5	10.5	16.5	12.0	12.0	55	6.02	50
	M 12	107R12		16	28	24.0	11.5	13.0	16.5	13.0	13.0	55	5.89	50
	M 14	107R14	*	16	28	24.0	11.5	15.0	16.5	14.5	14.5	55	5.80	25
	M 16	107R16		16	28	30.0	11.5	17.0	16.5	16.0	16.0	55	6.13	25
95	M 8	108R8	*	18	35	28.0	13.5	8.4	19.0	12.0	12.0	65	9.21	25
	M 10	108R10		18	35	28.0	13.5	10.5	19.0	12.0	12.0	65	8.97	50
	M 12	108R12		18	35	28.0	13.5	13.0	19.0	13.0	13.0	65	8.62	50
	M 14	108R14	*	18	35	28.0	13.5	15.0	19.0	14.5	14.5	65	8.78	25
	M 16	108R16		18	35	32.0	13.5	17.0	19.0	16.0	16.0	65	9.00	50
120	M 10	109R10		20	35	32.0	15.5	10.5	21.0	15.0	16.0	70	11.40	50
	M 12	109R12		20	35	32.0	15.5	13.0	21.0	16.0	17.0	70	11.31	50
	M 14	109R14	*	20	35	32.0	15.5	15.0	21.0	18.0	19.0	70	11.45	25
	M 16	109R16		20	35	32.0	15.5	17.0	21.0	19.0	20.0	70	11.24	50
	M 20	109R20		20	35	38.0	15.5	21.0	21.0	21.0	22.0	70	11.03	25
150	M 10	110R10		22	35	34.0	17.0	10.5	23.5	15.0	16.0	78	16.38	10
	M 12	110R12		22	35	34.0	17.0	13.0	23.5	16.0	17.0	78	16.29	25
	M 14	110R14	*	22	35	34.0	17.0	15.0	23.5	19.0	20.0	78	16.38	10
	M 16	110R16		22	35	34.0	17.0	17.0	23.5	19.0	20.0	78	16.17	10
	M 20	110R20		22	35	40.0	17.0	21.0	23.5	21.0	22.0	78	15.90	10
185	M 10	111R10		25	40	37.0	19.0	10.5	25.5	15.0	16.0	82	18.96	10
	M 12	111R12		25	40	37.0	19.0	13.0	25.5	16.0	17.0	82	18.11	10
	M 14	111R14	*	25	40	37.0	19.0	15.0	25.5	19.0	20.0	82	19.21	10
	M 16	111R16		25	40	37.0	19.0	17.0	25.5	19.0	20.0	82	18.74	25
	M 20	111R20		25	40	40.0	19.0	21.0	25.5	21.0	22.0	82	18.69	10
240	M 12	112R12		28	40	42.0	21.5	13.0	29.0	16.0	17.0	92	27.00	10
	M 14	112R14	*	28	40	42.0	21.5	15.0	29.0	19.0	20.0	92	27.58	10
	M 16	112R16		28	40	42.0	21.5	17.0	29.0	19.0	20.0	92	27.37	25
	M 20	112R20		28	40	45.0	21.5	21.0	29.0	21.0	22.0	92	26.88	10
300	M 14	113R14	*	32	50	46.0	24.5	15.0	32.0	19.0	22.0	100	33.29	5
	M 16	113R16		32	50	46.0	24.5	17.0	32.0	19.0	22.0	100	32.94	5
	M 20	113R20		32	50	46.0	24.5	21.0	32.0	22.0	22.0	100	33.24	5
400	M 14	114R14	*	38	70	54.0	27.5	15.0	38.5	25.0	25.0	115	69.38	5
	M 16	114R16		38	70	54.0	27.5	17.0	38.5	25.0	25.0	115	68.54	5
	M 20	114R20		38	70	54.0	27.5	21.0	38.5	25.0	25.0	115	65.40	5
500	M 16	115R16	*	42	70	60.0	31.0	17.0	42.0	25.0	25.0	125	83.31	1
	M 20	115R20		42	70	60.0	31.0	21.0	42.0	25.0	25.0	125	81.58	1
625	M 16	116R16	*	44	80	64.0	34.5	17.0	44.0	25.0	25.0	135	79.60	1
	M 20	116R20		44	80	64.0	34.5	21.0	44.0	25.0	25.0	135	79.69	1
800	M 16	117R16	*	52	100	75.0	40.0	17.0	52.0	30.0	30.0	165	150.00	1
	M 20	117R20		52	100	75.0	40.0	21.0	52.0	30.0	30.0	165	149.00	1
1000	M 16	118R16	*	58	100	83.0	44.0	17.0	58.0	30.0	30.0	165	199.00	1
	M 20	118R20		58	100	83.0	44.0	21.0	58.0	30.0	30.0	165	195.00	1



Angled compression cable lugs, Cu, 90° angled

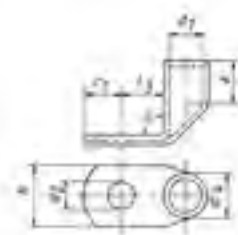

- ▶ For round conductors, e.g. to DIN EN 60228 Cl. 1, 2, 5 and 6
- ▶ For non-tension copper cables, e.g. to DIN 48201
- ▶ For pre-rounded multi-stranded sector shaped conductors
- ▶ Tube dimensions according to DIN 46235
- ▶ With code number for clear tool assignment

Characteristics

- Flat contact surface by special angle pressing process
- Easy to process due to crimp markings
- Annealed material optimises material and crimping properties
- Simple cable entry due to internal chamfer

Material

- Copper (EN13600)

Surface

- Tin-plated to protect against corrosion

Technical instructions

- Sleeves for compacted conductors and sleeves for 3-core and 4-core cables, see chapter „Sleeves for compacted conductors and sector shaped conductors - Cu“
- Tool: see page 69

Additional information

- Part Number appendix for bright version „BK“
- 10 - 240 mm² IEC-tested

Nominal cross section mm ²	Size of bolt diameter	Part No.	Code	Dimension mm							Weight/ 100 pcs. ~ kg	Packing unit/pcs
				a	b	d1	d2	d4	c1	l3		
6	M 5	161R5	5	10	8.5	3.8	5.3	5.5	6.5	9	0.28	50
	M 6	161R6	5	10	8.5	3.8	6.4	5.5	7.5	10	0.32	50
10	M 5	162R5	6	10	9.0	4.5	5.3	6.0	7.0	10	0.34	50
	M 6	162R6	6	10	9.0	4.5	6.4	6.0	7.5	10	0.35	50
16	M 8	162R8	6	10	13.0	4.5	8.4	6.0	10.0	13	0.37	50
	M 6	163R6	8	20	13.0	5.5	6.4	8.5	7.5	11	1.20	50
16	M 8	163R8	8	20	13.0	5.5	8.4	8.5	10.0	13	1.30	50
	M 10	163R10	8	20	17.0	5.5	10.5	8.5	12.0	15	1.40	50
25	M 12	163R12	8	20	18.0	5.5	13.0	8.5	13.0	18	1.33	50
	M 6	164R6	10	20	14.0	7.0	6.4	10.0	7.5	11	1.54	25
25	M 8	164R8	10	20	16.0	7.0	8.4	10.0	10.0	13	1.60	25
	M 10	164R10	10	20	17.0	7.0	10.5	10.0	12.0	15	1.63	25
35	M 12	164R12	10	20	19.0	7.0	13.0	10.0	13.0	18	1.70	25
	M 8	165R8	12	20	17.0	8.2	8.4	12.5	10.0	13	2.72	25
35	M 10	165R10	12	20	19.0	8.2	10.5	12.5	12.0	15	2.76	25
	M 12	165R12	12	20	21.0	8.2	13.0	12.5	13.0	18	2.85	25
50	M 14	165R14	12	20	21.0	8.2	15.0	12.5	14.5	20	2.92	25
	M 8	166R8	14	28	20.0	10.0	8.4	14.5	10.0	16	4.39	25
50	M 10	166R10	14	28	22.0	10.0	10.5	14.5	12.0	16	4.46	25
	M 12	166R12	14	28	24.0	10.0	13.0	14.5	13.0	18	4.49	25
50	M 14	166R14	14	28	24.0	10.0	15.0	14.5	14.5	20	4.73	25
	M 16	166R16	14	28	28.0	10.0	17.0	14.5	16.0	22	4.66	25

see next page



Angled compression cable lugs, Cu, 90° angled

Nominal cross section mm ²	Size of bolt diameter	Part No.	Code	Dimension mm						Weight/100 pcs. ~ kg	Packing unit/pcs	
				a	b	d1	d2	d4	c1			l3
70	M 8	167R8	16	28	24.0	11.5	8.4	16.5	10.0	14	5.92	25
	M 10	167R10	16	28	24.0	11.5	10.5	16.5	12.0	16	6.31	25
	M 12	167R12	16	28	24.0	11.5	13.0	16.5	13.0	18	6.34	25
	M 14	167R14	16	28	24.0	11.5	15.0	16.5	14.5	20	6.50	25
	M 16	167R16	16	28	30.0	11.5	17.0	16.5	16.0	22	6.63	25
95	M 10	168R10	18	35	28.0	13.5	10.5	19.0	12.0	17	9.03	25
	M 12	168R12	18	35	28.0	13.5	13.0	19.0	13.0	18	9.27	25
	M 14	168R14	18	35	28.0	13.5	15.0	19.0	14.5	20	9.06	25
	M 16	168R16	18	35	32.0	13.5	17.0	19.0	16.0	22	9.18	25
120	M 10	169R10	20	35	32.0	15.5	10.5	21.0	15.0	17	10.41	10
	M 12	169R12	20	35	32.0	15.5	13.0	21.0	16.0	18	10.65	10
	M 14	169R14	20	35	32.0	15.5	15.0	21.0	18.0	20	10.75	10
	M 16	169R16	20	35	32.0	15.5	17.0	21.0	19.0	22	10.72	10
	M 20	169R20	20	35	38.0	15.5	21.0	21.0	21.0	24	11.00	10
150	M 10	170R10	22	35	34.0	17.0	10.5	23.5	15.0	17	14.18	10
	M 12	170R12	22	35	34.0	17.0	13.0	23.5	16.0	18	14.33	10
	M 14	170R14	22	35	34.0	17.0	15.0	23.5	19.0	20	15.60	10
	M 16	170R16	22	35	34.0	17.0	17.0	23.5	19.0	22	15.24	10
	M 20	170R20	22	35	40.0	17.0	21.0	23.5	21.0	24	15.70	10
185	M 10	171R10	25	40	37.0	19.0	10.5	25.5	15.0	22	18.60	10
	M 12	171R12	25	40	37.0	19.0	13.0	25.5	16.0	22	18.69	10
	M 14	171R14	25	40	37.0	19.0	15.0	25.5	19.0	22	19.10	10
	M 16	171R16	25	40	37.0	19.0	17.0	25.5	19.0	22	19.00	10
	M 20	171R20	25	40	40.0	19.0	21.0	25.5	21.0	24	18.72	10
240	M 12	172R12	28	40	42.0	21.5	13.0	29.0	16.0	22	25.09	10
	M 14	172R14	28	40	42.0	21.5	15.0	29.0	19.0	22	25.70	10
	M 16	172R16	28	40	42.0	21.5	17.0	29.0	19.0	22	24.96	10
	M 20	172R20	28	40	45.0	21.5	21.0	29.0	21.0	24	25.26	10



Angled compression cable lugs, Cu, 45° angled

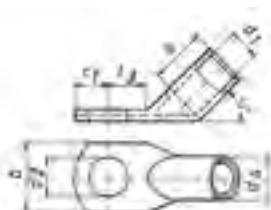

- ▶ For round conductors, e.g. to DIN EN 60228 Cl. 1, 2, 5 and 6
- ▶ For non-tension copper cables, e.g. to DIN 48201
- ▶ For pre-rounded multi-stranded sector shaped conductors
- ▶ Tube dimensions according to DIN 46235
- ▶ With code number for clear tool assignment

Characteristics

- Flat contact surface by special angle pressing process
- Easy to process due to crimp markings
- Annealed material optimises material and crimping properties
- Simple cable entry due to internal chamfer

Material

- Copper (EN13600)

Surface

- Tin-plated to protect against corrosion

Technical instructions

- Sleeves for compacted conductors and sleeves for 3-core and 4-core cables, see chapter „Sleeves for compacted conductors and sector shaped conductors - Cu“
- Tool: see page 69

Additional information

- Part Number appendix for bright version „BK“
- 10 - 240 mm² IEC-tested

Nominal cross section mm ²	Size of bolt diameter	Part No.	Code	Dimension mm							Weight/ 100 pcs. ~ kg.	Packing unit/pcs
				a	b	d1	d2	d4	c1	l3		
6	M 5	161R545	5	10	8.5	3.8	5.5	5.5	6.5	9	0.32	50
	M 6	161R645	5	10	8.5	3.8	6.5	5.5	7.5	10	0.34	50
10	M 5	162R545	6	10	9.0	4.5	5.5	6.0	7.0	10	0.36	50
	M 6	162R645	6	10	9.0	4.5	6.5	6.0	7.5	10	0.35	50
16	M 8	162R845	6	10	13.0	4.5	8.5	6.0	10.0	13	0.39	50
	M 6	163R645	8	20	13.0	5.5	6.5	8.5	7.5	11	1.20	50
	M 8	163R845	8	20	13.0	5.5	8.5	8.5	10.0	13	0.28	50
25	M 10	163R1045	8	20	17.0	5.5	10.5	8.5	12.0	15	1.34	50
	M 12	163R1245	8	20	18.0	5.5	13.0	8.5	13.0	18	1.35	50
	M 6	164R645	10	20	14.0	7.0	6.5	10.0	7.5	11	1.49	25
35	M 8	164R845	10	20	16.0	7.0	8.5	10.0	10.0	13	1.60	25
	M 10	164R1045	10	20	17.0	7.0	10.5	10.0	12.0	15	1.64	25
	M 12	164R1245	10	20	19.0	7.0	13.0	10.0	13.0	18	1.73	25
50	M 8	165R845	12	20	17.0	8.2	8.5	12.5	10.0	13	2.72	25
	M 10	165R1045	12	20	19.0	8.2	10.5	12.5	12.0	15	2.92	25
	M 12	165R1245	12	20	21.0	8.2	13.0	12.5	13.0	18	2.98	25
75	M 14	165R1445	12	20	21.0	8.2	15.0	12.5	14.5	20	3.03	25
	M 8	166R845	14	28	20.0	10.0	8.5	14.5	10.0	13	4.63	25
	M 10	166R1045	14	28	22.0	10.0	10.5	14.5	12.0	16	4.84	25
	M 12	166R1245	14	28	24.0	10.0	13.0	14.5	13.0	18	4.94	25
100	M 14	166R1445	14	28	24.0	10.0	15.0	14.5	14.5	20	4.96	25
	M 16	166R1645	14	28	28.0	10.0	17.0	14.5	16.0	22	4.92	25

see next page

Angled compression cable lugs, Cu, 45° angled

Nominal cross section mm ²	Size of bolt diameter	Part No.	Code	Dimension mm							Weight/100 pcs. ~ kg	Packing unit/pcs
				a	b	d1	d2	d4	c1	l3		
70	M 8	167R845	16	28	24.0	11.5	8.5	16.5	10.0	14	6.40	25
	M 10	167R1045	16	28	24.0	11.5	10.5	16.5	12.0	16	6.76	25
	M 12	167R1245	16	28	24.0	11.5	13.0	16.5	13.0	18	6.90	25
	M 14	167R1445	16	28	24.0	11.5	15.0	16.5	14.5	20	6.72	25
	M 16	167R1645	16	28	30.0	11.5	17.0	16.5	16.0	22	6.96	25
95	M 10	168R1045	18	35	28.0	13.5	10.5	19.0	12.0	17	9.64	25
	M 12	168R1245	18	35	28.0	13.5	13.0	19.0	13.0	18	9.21	25
	M 14	168R1445	18	35	28.0	13.5	15.0	19.0	14.5	20	9.51	25
	M 16	168R1645	18	35	32.0	13.5	17.0	19.0	16.0	22	9.40	25
120	M 10	169R1045	20	35	32.0	15.5	10.5	21.0	15.0	17	11.09	10
	M 12	169R1245	20	35	32.0	15.5	13.0	21.0	16.0	18	11.45	10
	M 14	169R1445	20	35	32.0	15.5	15.0	21.0	18.0	20	11.55	10
	M 16	169R1645	20	35	32.0	15.5	17.0	21.0	19.0	22	11.76	10
	M 20	169R2045	20	35	38.0	15.5	21.0	21.0	21.0	24	11.55	10
150	M 10	170R1045	22	35	34.0	17.0	10.5	23.5	15.0	17	15.93	10
	M 12	170R1245	22	35	34.0	17.0	13.0	23.5	16.0	18	16.08	10
	M 14	170R1445	22	35	34.0	17.0	15.0	23.5	19.0	20	16.38	10
	M 16	170R1645	22	35	34.0	17.0	17.0	23.5	19.0	22	16.90	10
	M 20	170R2045	22	35	40.0	17.0	21.0	23.5	21.0	24	16.49	10
185	M 10	171R1045	25	40	37.0	19.0	10.5	25.5	15.0	22	20.16	10
	M 12	171R1245	25	40	37.0	19.0	13.0	25.5	16.0	22	19.60	10
	M 14	171R1445	25	40	37.0	19.0	15.0	25.5	19.0	22	20.05	10
	M 16	171R1645	25	40	37.0	19.0	17.0	25.5	19.0	22	19.68	10
	M 20	171R2045	25	40	40.0	19.0	21.0	25.5	21.0	24	19.95	10
240	M 12	172R1245	28	40	42.0	21.5	13.0	29.0	16.0	22	26.46	10
	M 14	172R1445	28	40	42.0	21.5	15.0	29.0	19.0	22	26.99	10
	M 16	172R1645	28	40	42.0	21.5	17.0	29.0	19.0	22	26.92	10
	M 20	172R2045	28	40	45.0	21.5	21.0	29.0	21.0	24	26.88	10



Compression cable lugs to DIN special type, Cu with 2 holes

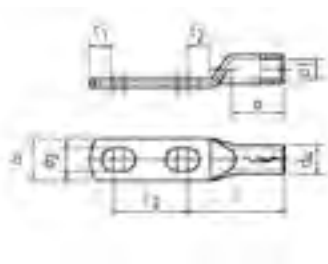

- ▶ For round conductors, e.g. to DIN EN 60228 Cl. 1, 2, 5 and 6
- ▶ For non-tension copper cables, e.g. to DIN 48201
- ▶ For pre-rounded sector shaped conductors
- ▶ Tube dimensions according to DIN 46235
- ▶ With code number for clear tool assignment

Characteristics

- Easy to process due to crimp markings
- Annealed material optimises material and crimping properties
- Flat contact surface by special pressing technique
- Internal chamfer for simple cable insertion

Material

- Copper (EN13600)

Surface

- Tin-plated to protect against corrosion

Technical instructions

- Sleeves for compacted conductors and sleeves for 3-core and 4-core cables, see chapter „Sleeves for compacted conductors and sector shaped conductors - Cu“
- Tool: see page 69

Additional information

- Part Number appendix for bright version „BK“

Nominal cross section mm ²	Size of bolt diameter	Part No.	Code	Dimension mm									Weight/100 pcs. ~ kg	Packing unit/pcs
				a	b	d1	d2	d4	c1	c2	l	l2		
70	2 x M 12	147D212	16	28	24	11.5	13	16.5	13	13	55	50 - 62	10.82	5
95		148D212	18	35	28	13.5	13	19.0	13	13	65	50 - 62	15.24	5
120		149D212	20	35	32	15.5	13	21.0	16	17	70	50 - 62	18.62	5
150		150D212	22	35	34	17.0	13	23.5	16	17	78	50 - 62	26.10	5
185		151D212	25	40	37	19.0	13	25.5	16	17	82	50 - 62	30.48	5
240		152D212	28	40	42	21.5	13	29.0	16	17	92	50 - 62	41.52	5



Compression cable lugs, special type, Cu with 1 hole, double crimping



- ▶ Special design for mounting of 2 multi-stranded cables, e.g. to DIN EN 60228 Cl. 2
- ▶ With crimp markings for correct crimp positioning

Characteristics

- Annealed material optimises material and crimping properties
- Simple and safe connection due to flat contact surfaces and internal chamfer

Material

- Copper (EN13600)

Surface

- Tin-plated to protect against corrosion

Technical instructions

- Tool: see page 70

Additional information

- Part Number appendix for bright version „BK“

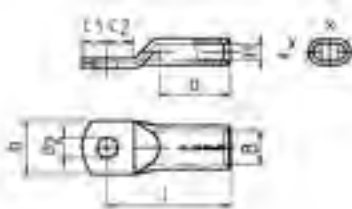

Nominal cross section mm ²	Size of bolt diameter	Part No.	Code	Dimension mm						H	B	Weight/100 pcs. ~ kg	Packing unit/pcs
				a	b	d2	c1	c2	l				
2 x 50	M 12	136DP12	22 DP	35	34	13	16	17	78	10.0	20	16.30	5
2 x 70		137DP12	24 DP	40	37	13	16	17	82	11.5	23	18.90	5
2 x 95		138DP12	29 DP	40	42	13	16	17	92	13.5	27	27.12	5
2 x 120		139DP12	32 DP	50	48	13	19	22	100	15.5	31	33.50	5

Compression cable lugs, special type, Cu with 2 long holes, double crimping



- ▶ Special design for mounting of 2 multi-stranded cables, e.g. to DIN EN 60228 Cl. 2
- ▶ With crimp markings for correct crimp positioning

Characteristics

- Annealed material optimises material and crimping properties
- Simple cable entry due to internal chamfer
- Flat contact surface by special pressing technique

Material

- Copper (EN13600)

Surface

- Tin-plated to protect against corrosion

Technical instructions

- Tool: see page 70

Additional information

- Part Number appendix for bright version „BK“

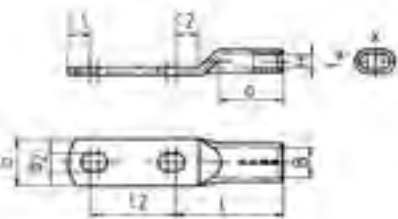

Nominal cross section mm ²	Size of bolt diameter	Part No.	Code	Dimension mm						H	B	Weight/100 pcs. ~ kg	Packing unit/pcs	
				a	b	d2	c1	c2	l					l2
2 x 50	2 x M 12	136DP212	22 DP	35	34	13	16	17	78	50 - 62	10.0	20	23.20	5
2 x 70		137DP212	24 DP	40	37	13	16	17	82	50 - 62	11.5	23	29.64	5
2 x 95		138DP212	29 DP	40	42	13	16	17	92	50 - 62	13.5	27	38.50	5
2 x 120		139DP212	32 DP	50	48	13	19	22	100	50 - 62	15.5	31	45.80	5



Compression joints to DIN, Cu

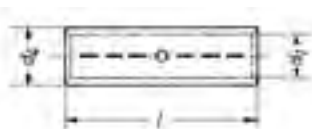

- ▶ For round conductors, e.g. to DIN EN 60228 Cl. 1, 2, 5 and 6 and pre-rounded sector shaped conductors
- ▶ For non-tension copper cables, e.g. to DIN 48201
- ▶ To DIN 46267, Part 1
- ▶ With code number for clear tool assignment
- ▶ With crimp markings for correct crimp positioning

Characteristics

- Simple and safe processing due to butt mark
- Annealed material optimises material and crimping properties
- Simple cable entry due to internal chamfer

Material

- Copper (EN13600)

Surface

- Tin-plated to protect against corrosion

Technical instructions

- Sleeves for compacted conductors and sleeves for 3-core and 4-core cables, see chapter „Sleeves for compacted conductors and sector shaped conductors - Cu“
- Tool: see page 69
- Reduction sleeves for connecting unequal cross-sections can be found on page 68

Additional information

- Part Number appendix for bright version „BK“
- 10 - 800 mm² IEC-tested

Nominal cross section mm ²	Part No.	Code	Dimension mm			Weight/ 100 pcs. ~ kg	Packing unit/pcs
			d1	d4	l		
6	121R	5	3.8	5.5	30	0.31	100
10	122R	6	4.5	6.0	30	0.34	100
16	123R	8	5.5	8.5	50	1.45	100
25	124R	10	7.0	10.0	50	1.77	50
35	125R	12	8.2	12.5	50	2.89	50
50	126R	14	10.0	14.5	56	4.26	50
70	127R	16	11.5	16.5	56	5.41	50
95	128R	18	13.5	19.0	70	8.62	25
120	129R	20	15.5	21.0	70	9.66	25
150	130R	22	17.0	23.5	80	14.50	10
185	131R	25	19.0	25.5	85	17.00	10
240	132R	28	21.5	29.0	90	23.41	10
300	133R	32	24.5	32.0	100	29.23	5
400	134R	38	27.5	38.5	150	74.32	5
500	135R	42	31.0	42.0	160	89.09	1
625	136R	44	34.5	44.0	160	79.10	1
800	137R	52	40.0	52.0	200	151.00	1
1000	138R	58	44.0	58.0	200	198.00	1

Compression joints, Cu



- ▶ For round conductors, e.g. to DIN EN 60228 Cl. 1, 2, 5 and 6 and pre-rounded sector shaped conductors
- ▶ For non-tension copper cables, e.g. to DIN 48201
- ▶ Barrier design with oil stop
- ▶ Tube dimension to DIN 46267, part 1
- ▶ With code number for clear tool assignment

Characteristics

- Easy to process due to crimp markings
- Annealed material optimises material and crimping properties
- Simple cable entry due to internal chamfer

Suitable for

- Non-tension connections

Material

- Copper (EN13600)

Surface

- Tin-plated to protect against corrosion

Technical instructions

- Sleeves for compacted conductors and sleeves for 3-core and 4-core cables, see chapter „Sleeves for compacted conductors and sector shaped conductors - Cu“
- Tool: see page 69
- Reduction sleeves for connecting unequal cross-sections can be found on page 68

Additional information

- Part Number appendix for bright version „BK“

Nominal cross section mm ²	Part No.	Code	Dimension mm			Weight/ 100 pcs. ~ kg	Packing unit/pcs
			d1	d4	l		
16	523R	8	5.5	8.5	50	1.54	25
25	524R	10	7.0	10.0	50	1.84	25
35	525R	12	8.2	12.5	50	2.99	25
50	526R	14	10.0	14.5	56	4.46	25
70	527R	16	11.5	16.5	56	5.61	25
95	528R	18	13.5	19.0	70	8.88	25
120	529R	20	15.5	21.0	70	10.06	5
150	530R	22	17.0	23.5	80	14.89	5
185	531R	25	19.0	25.5	85	17.57	5
240	532R	28	21.5	29.0	90	24.23	5
300	533R	32	24.5	32.0	100	30.15	5
400	534R	38	27.5	38.5	150	75.60	5
500	535R	42	31.0	42.0	160	92.00	1
625	536R	44	34.5	44.0	160	81.50	1

Compression joint for cable connections 10-30 kV, copper

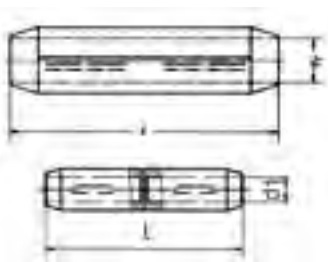
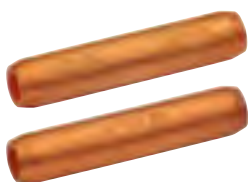

- ▶ For round conductors, e.g. to DIN EN 60228 Cl. 2 and pre-rounded sector shaped conductors
- ▶ For non-tension copper cables, e.g. to DIN 48201
- ▶ Tube dimension to DIN 46267, part 1
- ▶ For copper medium-voltage cable connections 10 - 30 kV
- ▶ With chamfered edges for reduced electrical stress in the assembly

Characteristics

- Also available as barrier design with oil stop
- Easy to process due to crimp markings
- Annealed material optimises material and crimping properties
- Simple cable entry due to internal chamfer

Suitable for

- Non-tension connections

Material

- Copper (EN13600)

Surface

- Bright

Technical instructions

- Tool: see page 69
- Reduction sleeves for connecting unequal cross-sections can be found on page 68

Additional information

- Part Number appendix for tinned version „V“

Nominal cross section mm ²	Part No.	Code	Dimension mm		Number of crimps		Weight/ 100 pcs. ~ kg	Packing unit/pcs
			d1	l	Cu (5 mm)	Cu (wide)		
Standard version								
25	504R	12	7.5	60	2/2	1/1	4.08	10
35	505R	12	8.2	60	2/2	1/1	3.56	10
50	506R	14	10.0	65	3/3	1/1	4.90	10
70	507R	16	11.5	65	3/3	1/1	6.10	10
95	508R	18	13.5	90	4/4	2/2	10.98	10
120	509R	20	15.5	90	4/4	2/2	12.68	5
150	510R	22	17.0	105	4/4	2/2	18.09	5
185	511R	25	19.0	105	4/4	2/2	20.35	5
240	512R	28	21.5	125		2/2	31.64	5
300	513R	32	24.5	125		2/2	35.40	1
400	514R	38	27.5	160		3/3	75.42	1
Barrier version								
25	504RLD	12	7.5	60	2/2	1/1	4.08	25
35	505RLD	12	8.2	60	2/2	1/1	3.56	10
50	506RLD	14	10.0	65	3/3	1/1	4.90	10
70	507RLD	16	11.5	65	3/3	1/1	6.40	10
95	508RLD	18	13.5	90	4/4	2/2	10.98	10
120	509RLD	20	15.5	90	4/4	2/2	12.68	5
150	510RLD	22	17.0	105	4/4	2/2	18.84	5
185	511RLD	25	19.0	105	4/4	2/2	20.35	5
240	512RLD	28	21.5	125		2/2	31.64	5
300	513RLD	32	24.5	125		2/2	35.40	1
400	514RLD	38	27.5	160		3/3	75.42	1



Compression joints to DIN, Cu



- ▶ For connecting copper cables to DIN 48201, Part 1
- ▶ For full tension cable connections
- ▶ To DIN 48085, Part 1
- ▶ With code number for clear tool assignment
- ▶ With crimp markings for correct crimping

Characteristics

- Easy to process due to crimp markings
- Simple and safe processing due to butt mark
- Simple cable entry due to internal chamfer

Material

- Copper (EN13600)

Surface

- Bright

Technical instructions

- To process item 192R use crimping die HAD45240
- Tool: see page 69

Additional information

- * = not standardised
- 16 - 70 mm² IEC-tested

Nominal cross section mm ²	Part No.	Hint	Code	Dimension mm			Number of crimps		conductor dia. mm	Weight/ 100 pcs. ~ kg	Packing unit/pcs
				d1	d4	l	Cu (5 mm)	Cu (wide)			
6	181R	*	6	3.5	6.5	65	4/4		3.00	1.4	10
10	182R		8	4.5	8.5	80	5/5		4.05	3.0	10
16	183R		8	5.5	8.5	95	5/5		5.10	2.8	10
25	184R		10	7.0	10.0	95	5/5		6.30	3.4	10
35	185R		12	8.2	12.5	95	5/5		7.50	5.6	10
50	186R		14	10.0	14.5	110	5/5		9.00	8.6	10
70	187R		16	11.5	16.5	110	5/5		10.50	10.8	10
95	188R		20	13.5	21.0	145	8/8	4/4	12.50	26.2	10
120	189R		22	15.0	23.5	160	8/8	4/4	14.00	36.8	10
150	190R		25	16.5	25.5	180	8/8	4/4	15.70	47.5	5
185	191R	*	32	18.5	31.5	260		5/5	17.50	118.0	5
240	192R	*	34	21.0	34.5	310		6/6	20.20	163.0	5
300	193R	*	38	23.5	38.5	360		7/7	22.50	235.0	1



Reduction sleeves, Cu



- ▶ For multi-stranded, round conductors e.g. to DIN EN 60228
- ▶ For connecting different conductor cross-sections
- ▶ For use in DIN compression joints and connectors, standard type
- ▶ For non-tension copper cables acc. to DIN 48201 part 1

Characteristics

- Simple cable entry due to internal chamfer

Suitable for

- For non-tension compression joints

Material

- Copper (EN13600)

Surface

- Bright

Technical instructions

- Refer to the installation instructions in the technical appendix on page i-7

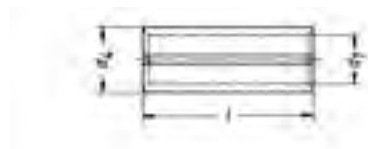

Part No.	Nominal cross section mm ² from	Nominal cross section mm ² to	Dimension mm			Weight/100 pcs. ~ kg	Packing unit/pcs
			d1	d4	l		
RH2510	25	10	4.6	6.6	25	0.358	25
RH2516	25	16	5.5	6.6	25	0.350	25
RH3510	35	10	4.5	8.0	25	0.707	25
RH3516	35	16	5.5	8.0	25	0.570	25
RH3525	35	25	7.0	8.0	25	0.253	25
RH5016	50	16	5.5	9.5	33	1.326	25
RH5025	50	25	7.0	9.5	33	0.923	25
RH5035	50	35	8.5	9.5	33	0.404	25
RH7025	70	25	7.0	11.0	33	1.580	25
RH7035	70	35	8.5	11.0	33	1.102	25
RH7050	70	50	10.0	11.0	33	0.486	25
RH9535	95	35	8.5	13.0	45	2.940	25
RH9550	95	50	10.0	13.0	45	2.136	25
RH9570	95	70	11.5	13.0	45	1.100	25
RH12050	120	50	10.0	15.0	45	3.802	25
RH12070	120	70	11.5	15.0	45	2.874	25
RH12095	120	95	13.5	15.0	45	1.340	25
RH15070	150	70	11.5	16.5	53	5.008	5
RH15095	150	95	13.5	16.5	53	3.212	5
RH150120	150	120	15.5	16.5	53	1.248	5
RH18595	185	95	13.5	18.5	53	5.824	5
RH185120	185	120	15.5	18.5	53	3.756	5
RH185150	185	150	17.0	18.5	53	1.660	5
RH240120	240	120	15.5	21.0	55	7.412	5
RH240150	240	150	17.0	21.0	55	5.740	5
RH240185	240	185	19.0	21.0	55	3.036	5
RH300150	300	150	17.0	24.0	58	11.200	5
RH300185	300	185	19.0	24.0	58	8.390	5
RH300240	300	240	21.5	24.0	58	4.526	5
RH400185	400	185	19.0	27.0	80	20.100	5
RH400240	400	240	21.5	27.0	80	14.270	5
RH400300	400	300	24.5	27.0	80	8.800	5

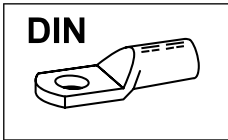

Tool application chart

Compression cable lugs and compression joints

Tool type	Crimping range corresponds to nominal cross-section mm ²	Crimping Tool		Catalogue page		Crimp profile
		Part No.	Crimping head / adapter	Crimping Tool	Crimping die	
Mechanical crimping tools	6-50	K05D		235		⬡
	10-120	K06D		237		⬡
	25-150	K09D		238		⬡
Mechanical, electrical, pneumatic crimping tools with interchangeable dies / heads	6-120	K354		246	330	⬡
	6-185	K18		248	338	⬡
	6-240	K22		250	343	⬡
Hand hydraulic crimping tools	6-185	HK6018		292	338	⬡
		HK60UNV	+UA18	473	338	⬡
	6-300	HK6022		294	343	⬡
		HK60UNV	+UA22	473	343	⬡
	16-300	HK12030		298	348	⬡
		HK12042		300	348	⬡
		HK120U		302	348	⬡
120-1000	HK45		321	358	⬡	
Battery powered crimping tools	6-120	EK354ML		262	330	⬡
		EK354		266	330	⬡
	6-185	EK505		268	334	⬡
		EK5018		270	338	⬡
		EK60UNV	+UA18	476	338	⬡
		EKM60UNV	+UA18	475	338	⬡
		EK6022		247	343	⬡
	6-300	EKM6022		272	343	⬡
		EK60UNV	+UA22	476	343	⬡
		EKM60UNV	+UA22	475	343	⬡
		EK12032		280	348	⬡
	16-300	EK12042		282	348	⬡
		EK120U		284	348	⬡
		EK120UNV	+UA12T	477	348	⬡
		EK135FT	+UA15T	286	348	⬡
400-625	EK135FT		286	352	⬡	
Hydraulic crimping systems	6-185	THK18		306	338	⬡
	6-240	THK22		308	343	⬡
		HK122EL380		322	343	⬡
	16-625	HK252		320	354	⬡
		HK252EL380		323	354	⬡
Hydraulic crimping heads	6-185	PK18		306	338	⬡
		PK60UNV	+UA18	474	338	⬡
	6-300	PK22		308	343	⬡
		PK60UNV	+UA22	474	343	⬡
	16-300	PK12042		312	348	⬡
		PK120U		314	348	⬡
	16-625	PK252		316	354	⬡
	120-1000	PK45		318	358	⬡

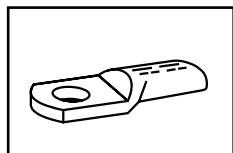

Tool application chart

Double compression cable lugs

Tool type	Crimping range corresponds to nominal cross-section mm ²	Crimping Tool		Catalogue page		Crimp profile
		Part No.	Crimping head / adapter	Crimping Tool	Crimping die	
Mechanical, electrical, pneumatic crimping tools with interchangeable dies / heads	2x50-2x70	K22		250	343	○
Hand hydraulic crimping tools	2x50-2x70	HK6022		294	343	○
		HK60UNV	+UA22	473	343	○
	2x50-2x95	HK12030		298	348	○
		HK12042		300	348	○
Battery powered crimping tools	2x50-2x70	EK6022		274	343	○
		EKM6022		272	343	○
		EK60UNV	+UA22	476	343	○
		EKM60UNV	+UA22	475	343	○
	2x50-2x95	EK12032		280	348	○
		EK12042		282	348	○
		EK120U		284	348	○
		EK135FT	+UA15T	286	348	○
		EK120UNV	+UA12T	477	348	○
Hydraulic crimping systems	2x50-2x70	THK22		308	343	○
	2x50-2x95	HK122EL380		322	348	○
	2x50-2x120	HK252		320	354	○
		HK252EL380		323	354	○
Hydraulic crimping heads	2x50-2x70	PK22		308	343	○
		PK60UNV	+UA22	474	343	○
	2x50-2x95	PK12042		312	348	○
		PK120U		314	348	○
	2x50-2x120	PK252		316	354	○



PUNCHED - SOLDERLESS TERMINALS MADE FROM COPPER TO DIN 46234

Unlike the tubular cable lugs, Klauke solderless terminals are punched from a sheet, bent and then hard soldered in the crimp area. The grooved profile on the inside ensures higher conductor pull-out values. This product's small dimensions make it the ideal solution for confined areas.



In brief

- ▶ Reliable crimping due to high-quality solder seam
- ▶ Small dimensions for confined areas
- ▶ Suitable for multi-stranded, fine-stranded and superfine-stranded conductors



▶ Hard soldered for reliable contact

The quality of Klauke cable lugs is also evident during the crimping operation: The solderless terminal always remains intact due to the high-quality solder seam. Guaranteed quality.

- Reliable contact due to high-quality solder seam and tinning
- Best possible contacting with ribbed profile
- Optimum solution for confined areas thanks to highly-compact dimensions
- Insulated and non-insulated versions

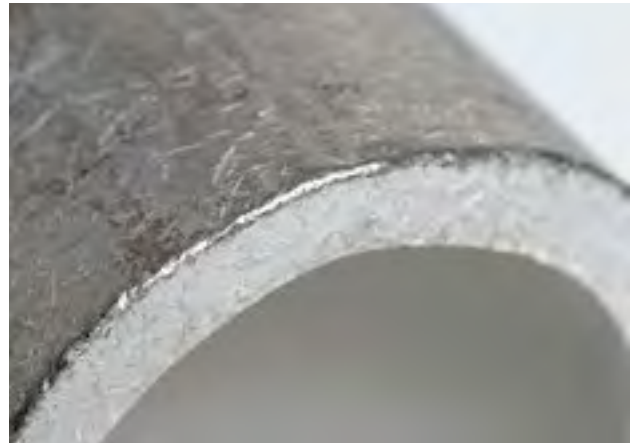

▶ Well insulated

Klauke products make your day-to-day work easier. Thanks to the widened insulation, the conductor can be very conveniently inserted into our insulated solderless terminals. The insulation remains intact even after crimping, eliminating the need for retrospective insulation. Everything accomplished in one operation.

- Easy to use thanks to widened sleeve
- No additional insulation, hence fast processing
- As a fork-type, ideal for connecting meters in confined areas for example
- Easy conductor insertion thanks to widened sleeve





Solderless terminals to DIN, Cu

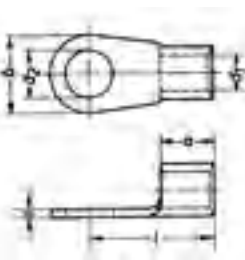

- ▶ For round conductors, e.g. to DIN EN 60228 Cl. 2, 5 and 6
- ▶ To DIN 46234
- ▶ High-quality brazing process in the crimp area

Characteristics

- Improved contact properties due to grooved profile

Material

- Copper (ETP)

Surface

- Tin-plated to protect against corrosion

Technical instructions

- Tool: see page 82

Additional information

- * = not standardised
- 0.5 - 6 mm² not UL-tested

Nominal cross section mm ²	Nominal size to DIN	Part No.	Hint	Dimension mm						Weight/100 pcs. ~ kg	Packing unit/pcs
				a	b	d1	d2	l	s		
0.5 - 1	2.5 - 1	162025		5	6	1.6	2.8	11	0.8	0.060	100
	3 - 1	16203		5	6	1.6	3.2	11	0.8	0.060	100
	3.5 - 1	162035		5	6	1.6	3.7	11	0.8	0.055	100
	4 - 1	16204		5	8	1.6	4.3	12	0.8	0.070	100
	5 - 1	16205		5	10	1.6	5.3	13	0.8	0.090	100
	6 - 1	16206	*	5	11	1.6	6.5	15	0.8	0.080	100
	8 - 1	16208	*	5	14	1.6	8.4	17	0.8	0.130	100
	10 - 1	162010	*	5	18	1.6	10.5	19	0.8	0.130	100
1.5 - 2.5	3 - 2.5	16303		5	6	2.3	3.2	11	0.8	0.065	100
	4 - 2.5	16304		5	8	2.3	4.3	12	0.8	0.080	100
	3.5 - 2.5	163035		5	6	2.3	3.7	11	0.8	0.065	100
	5 - 2.5	16305		5	10	2.3	5.3	14	0.8	0.090	100
	6 - 2.5	16306		5	11	2.3	6.5	16	0.8	0.110	100
	8 - 2.5	16308		5	14	2.3	8.4	17	0.8	0.130	100
	10 - 2.5	163010	*	5	15	2.3	10.5	17	0.8	0.160	100
12 - 2.5	163012	*	5	18	2.3	13.0	19	0.8	0.160	100	
4 - 6	4 - 6	16504		6	8	3.6	4.3	14	1.0	0.140	100
	5 - 6	16505		6	10	3.6	5.3	15	1.0	0.160	100
	6 - 6	16506		6	11	3.6	6.5	16	1.0	0.170	100
	8 - 6	16508		6	14	3.6	8.4	19	1.0	0.220	100
	10 - 6	165010		6	18	3.6	10.5	21	1.0	0.290	100
	12 - 6	165012	*	6	18	3.6	13.0	21	1.0	0.280	100
10	5 - 10	16525		8	10	4.5	5.3	16	1.1	0.230	100
	6 - 10	16526		8	11	4.5	6.5	17	1.1	0.24	100
	8 - 10	16528		8	14	4.5	8.4	20	1.1	0.340	100
	10 - 10	165210		8	18	4.5	10.5	21	1.1	0.340	100
	12 - 10	165212		8	22	4.5	13.9	23	1.1	0.420	100
16	5 - 16	16535		10	11	5.8	5.3	20	1.2	0.390	100
	6 - 16	16536		10	11	5.8	6.5	20	1.2	0.380	100
	8 - 16	16538		10	14	5.8	8.4	22	1.2	0.43	100
	10 - 16	165310		10	18	5.8	10.5	24	1.2	0.500	100
	12 - 16	165312		10	18	5.8	10.5	24	1.2	0.500	100

see next page



Solderless terminals to DIN, Cu

Nominal cross section mm ²	Nominal size to DIN	Part No.	Hint	Dimension mm						Weight/100 pcs. ~ kg	Packing unit/pcs
				a	b	d1	d2	l	s		
25	5 - 25	16545		11	12	7.5	5.3	25	1.5	0.750	100
	6 - 25	16546		11	12	7.5	6.5	25	1.5	0.750	100
	8 - 25	16548		11	16	7.5	8.4	25	1.5	0.750	100
	10 - 25	165410		11	18	7.5	10.5	26	1.5	0.750	100
	12 - 25	165412		11	22	7.5	13.0	31	1.5	0.920	100
	16 - 25	165416		11	28	7.5	17.0	35	1.5	1.320	100
35	6 - 35	16556		12	16	9.0	8.4	26	1.6	0.980	100
	8 - 35	16558		12	16	9.0	8.4	26	1.6	0.980	100
	10 - 35	165510		12	18	9.0	10.5	27	1.6	1.000	100
	12 - 35	165512		12	22	9.0	13.0	31	1.6	1.260	100
	16 - 35	165516		12	28	9.0	17.0	36	1.6	1.550	100
50	6 - 50	16566		16	18	11.0	6.5	34	1.8	1.650	100
	8 - 50	16568		16	18	11.0	8.4	34	1.8	1.650	100
	10 - 50	165610		16	18	11.0	10.5	34	1.8	1.600	100
	12 - 50	165612		16	22	11.0	13.0	36	1.8	1.800	100
	16 - 50	165616		16	28	11.0	17.0	40	1.8	2.100	100
70	6 - 70	16576		18	22	13.0	6.5	38	2.0	2.600	50
	8 - 70	16578		18	22	13.0	8.4	38	2.0	2.500	50
	10 - 70	165710		18	22	13.0	10.5	38	2.0	2.500	50
	12 - 70	165712		18	22	13.0	13.0	38	2.0	2.400	50
	16 - 70	165716		18	28	13.0	17.0	42	2.0	2.700	50
95	8 - 95	16588		20	24	15.0	8.4	42	2.5	4.300	50
	10 - 95	165810		20	24	15.0	10.5	42	2.5	4.1	50
	12 - 95	165812		20	24	15.0	13.0	42	2.5	3.900	50
	16 - 95	165816		20	28	15.0	17.0	44	2.5	4.100	50
120	8 - 120	16598		22	24	17.0	8.4	44	3.0	5.601	50
	10 - 120	165910		22	24	17.0	10.5	44	3.0	5.600	50
	12 - 120	165912		22	24	17.0	13.0	44	3.0	5.400	50
	16 - 120	165916		22	28	17.0	17.0	48	3.0	5.800	50
150	10 - 150	166010		24	30	19.0	10.5	50	3.2	7.600	50
	12 - 150	166012		24	30	19.0	13.0	50	3.2	7.600	50
	16 - 150	166016		24	30	19.0	17.0	50	3.2	7.500	50
185	12 - 185	166112		28	36	21.0	13.0	50	3.5	11.300	50
	16 - 185	166116		28	36	21.0	17.0	50	3.5	11.300	50
240	12 - 240	166212		32	38	23.5	13.0	56	4.0	15.900	25
	16 - 240	166216		32	38	23.5	17.0	56	4.0	15.900	25



Insulated solderless terminals, Cu with Easy-Entry

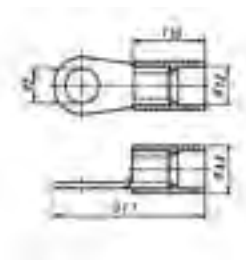

- ▶ For round conductors, e.g. to DIN EN 60228 Cl. 2, 5 and 6
- ▶ High-quality brazing process in the crimp area
- ▶ Fast preparation as no additional insulation of the crimped connection is required
- ▶ Simple processing due to crimping over the insulation

Characteristics

- Insulating, halogen-free with easy-entry cable insertion
- Dimensions in tube according to DIN 46234
- Improved contact properties due to grooved profile
- Cross-section-dependent colour-coding
- Heat resistant to 105° C

Material

- Copper (ETP)
- Insulation sleeve: PA

Surface

- Tin-plated to protect against corrosion

Technical instructions

- Tool: see page 84

Nominal cross section mm ²	Part No.	Colour	Dimension mm					Gewicht 100 St. ~kg Cu	Gewicht 100 St. ~kg Ges.	Packing unit/ pcs
			d12	d13	d2	Gl1	l10			
10	6525	■	6.7	8.6	5.3	34.0	19.0	0.27	0.27	100
	6526	■	6.7	8.6	6.5	34.0	19.0	0.24	0.28	100
	6528	■	6.7	8.6	8.4	37.5	19.0	0.29	0.33	100
	65210	■	6.7	8.6	10.5	41.5	19.0	0.34	0.38	100
	65212	■	6.7	8.6	13.0	45.5	19.0	0.42	0.46	100
16	6535	■	7.7	9.6	5.3	39.5	20.5	0.39	0.44	100
	6536	■	7.7	9.6	6.5	39.5	20.5	0.38	0.43	100
	6538	■	7.7	9.6	8.4	41.5	20.5	0.43	0.48	100
	65310	■	7.7	9.6	10.5	43.5	20.5	0.50	0.55	100
	65312	■	7.7	9.6	13.0	50.5	20.5	0.58	0.63	100
25	6545	■	11.0	13.0	5.3	40.0	20.0	0.75	0.84	50
	6546	■	11.0	13.0	6.5	42.5	20.0	0.69	0.78	50
	6548	■	11.0	13.0	8.4	43.0	20.0	0.75	0.84	50
	65410	■	11.0	13.0	10.5	45.0	20.0	0.80	0.89	50
	65412	■	11.0	13.0	13.0	51.0	20.0	0.92	1.00	50
35	65416	■	11.0	13.0	17.0	59.0	20.0	1.32	1.40	50
	6556	■	12.7	15.0	6.5	44.0	22.5	1.01	1.14	50
	6558	■	12.7	15.0	8.4	44.5	22.5	0.98	1.10	50
	65510	■	12.7	15.0	10.5	46.5	22.5	1.00	1.12	50
	65512	■	12.7	15.0	13.0	52.5	22.5	1.26	1.38	50
50	65516	■	12.7	15.0	17.0	54.5	22.5	1.55	1.67	50
	6566	■	15.4	18.0	6.5	54.5	27.5	1.65	1.90	50
	6568	■	15.4	18.0	8.4	60.5	27.5	1.65	1.90	50
	65610	■	15.4	18.0	10.5	60.5	27.5	1.60	1.85	50
	65612	■	15.4	18.0	13.0	60.5	27.5	1.80	2.05	50
	65616	■	15.4	18.0	17.0	67.5	27.5	2.10	2.35	50

see next page



Insulated solderless terminals, Cu with Easy-Entry

Nominal cross section mm ²	Part No.	Colour	Dimension mm					Weight 100 pcs. ~kg Cu	Weight 100 pcs. ~kg Total	Packing unit/ pcs
			d12	d13	d2	Gl1	l10			
70	6576	Yellow	17.4	20.0	6.5	61.5	30.5	2.60	2.90	50
	6578	Yellow	17.4	20.0	8.4	61.5	30.5	2.50	2.80	50
	65710	Yellow	17.4	20.0	10.5	66.5	30.5	2.50	2.80	50
	65712	Yellow	17.4	20.0	13.0	66.5	30.5	2.40	2.70	50
	65716	Yellow	17.4	20.0	17.0	70.5	30.5	2.70	3.00	50
95	65810	Red	20.5	23.5	10.5	70.0	34.0	4.10	4.50	25
	65812	Red	20.5	23.5	13.0	70.0	34.0	3.90	4.40	25
	65816	Red	20.5	23.5	17.0	76.0	34.0	4.10	4.50	25
120	65910	Dark Blue	23.5	26.7	10.5	79.0	36.0	5.60	6.10	25
	65912	Dark Blue	23.5	26.7	13.0	82.0	36.0	5.40	5.90	25
	65916	Dark Blue	23.5	26.7	17.0	90.0	36.0	5.80	6.30	25
150	66010	Yellow	26.0	29.2	10.5	80.0	39.0	7.60	8.40	25
	66012	Yellow	26.0	29.2	13.0	83.0	39.0	7.60	8.40	25
	66016	Yellow	26.0	29.2	17.0	83.0	39.0	7.50	8.30	25

Insulated pin terminals, Cu with Easy-Entry

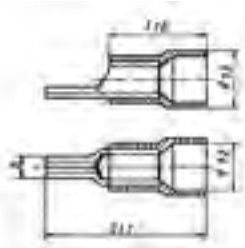

- ▶ For round conductors, e.g. to DIN EN 60228 Cl. 2, 5 and 6
- ▶ High-quality brazing process in the crimp area
- ▶ Fast preparation as no additional insulation of the crimped connection is required

Characteristics

- Insulating, halogen-free with easy-entry cable insertion
- Improved contact properties due to grooved profile
- Cross-section-dependent colour-coding
- Heat resistant to 105° C

Material

- Copper (ETP)
- Insulation sleeve: PA

Surface

- Tin-plated to protect against corrosion

Technical instructions

- Tool: see page 84

Nominal cross section mm ²	Part No.	Colour	Dimension mm					Weight 100 pcs. ~kg Cu	Weight 100 pcs. ~kg Total	Packing unit/ pcs
			b	d12	d13	Gl1	l10			
10	ST1716IS	Red	4.3	7.4	9.4	33.0	19.0	0.27	0.31	100
16	ST1717IS	Dark Blue	5.5	8.6	10.6	38.0	20.0	0.39	0.44	100
25	ST1718IS	Yellow	6.8	12.5	14.5	43.5	23.5	0.63	0.73	50
35	ST1719IS	Red	8.0	14.0	16.4	51.5	27.5	1.17	1.34	50
50	ST1720IS	Dark Blue	9.5	15.5	18.0	59.0	33.0	1.79	2.10	50
70	ST1721IS	Yellow	11.0	18.0	20.5	69.0	38.0	2.92	3.20	50
95	ST1722IS	Red	12.5	20.7	23.5	71.0	40.0	4.30	4.70	25



Solderless terminals, Cu, fork type

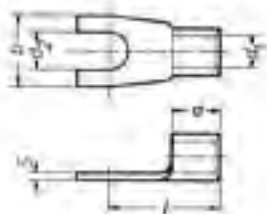

- ▶ For round conductors, e.g. to DIN EN 60228 Cl. 2, 5 and 6
- ▶ Dimensions in tube to 6 mm² to DIN 46234
- ▶ Simple fork-type mounting
- ▶ High-quality brazing process in the crimp area



Characteristics

- Improved contact properties due to grooved profile



Material

- Copper (ETP)



Surface

- Tin-plated to protect against corrosion



Technical instructions

- Tool: see page 82

Additional information

- 0.5 - 6 mm² not UL-certified

Nominal cross section mm ²	Nominal size to DIN	Part No.	Dimension mm						Weight 100 pcs. ~kg	Packing unit/ pcs
			a	b	d1	d2	l	s		
0.5 - 1	3 - 1	1620C3	5.0	6.0	1.6	3.2	11.0	0.8	0.060	100
	3.5 - 1	1620C35	5.0	6.0	1.6	3.7	11.0	0.8	0.060	100
	4 - 1	1620C4	5.0	6.8	1.6	4.3	12.0	0.8	0.070	100
	5 - 1	1620C5	5.0	10.0	1.6	5.3	13.0	0.8	0.090	100
	6 - 1	1620C6	5.0	11.0	1.6	6.5	15.0	0.8	0.080	100
1.5 - 2.5	3 - 2.5	1630C3	5.0	5.5	2.3	3.2	13.8	0.8	0.065	100
	3.5 - 2.5	1630C35	5.0	6.0	2.3	3.7	11.0	0.8	0.065	100
	4 - 2.5	1630C4	5.0	6.8	2.3	4.3	12.0	0.8	0.080	100
	5 - 2.5	1630C5	5.0	10.0	2.3	5.3	14.0	0.8	0.090	100
	6 - 2.5	1630C6	5.0	11.0	2.3	6.5	16.0	0.8	0.110	100
4 - 6	4 - 6	1650C4	6.0	8.0	3.6	4.3	14.0	1.0	0.140	100
	5 - 6	1650C5	6.0	10.0	3.6	5.3	15.0	1.0	0.160	100
	6 - 6	1650C6	6.0	11.0	3.6	6.5	16.0	1.0	0.170	100
	8 - 6	1650C8	6.0	14.0	3.6	8.4	19.0	1.0	0.220	100
10	5 - 10	1652C5	10.0	10.0	4.3	5.3	19.0	1.0	0.240	100
	6 - 10	1652C6	10.0	11.0	4.3	6.4	21.0	1.0	0.260	100
16	6 - 16	1653C6	11.5	11.0	5.4	6.4	24.0	1.0	0.350	100
	8 - 16	1653C8	11.5	15.0	5.4	8.4	27.0	1.0	0.420	100



Pin terminals to DIN, Cu



- ▶ For round conductors, e.g. to DIN EN 60228 Cl. 2, 5 and 6
- ▶ Nominal cross-sections 0.5 - 6 mm² to DIN 46230
- ▶ High-quality brazing process in the crimp area



Characteristics

- Improved contact properties due to grooved profile



Material

- Copper (ETP)



Surface

- Tin-plated to protect against corrosion



Technical instructions

- Tool: see page 82

Additional information

- * = not standardised
- 0.5 - 6 mm² not UL-tested

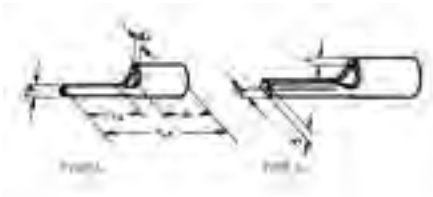

Nominal cross section mm ²	Nominal size to DIN	Part No.	Typ	Hint	Dimension mm								Weight 100 pcs. ~kg	Packing unit/pcs
					a	b	d1	d2	l1	l2	s	h		
0.5 - 1	1	ST1705	A		5.0	--	1.8	1.9	17.0	10	0.8	--	0.060	100
1.5 - 2.5	2.5	ST1710	A		5.0	--	2.3	1.9	17.0	10	0.8	--	0.072	100
4 - 6	6	ST1715	A		6.0	--	3.6	2.7	20.0	11	1.0	--	0.160	100
10	--	ST1716	B	*	10.0	4.3	4.3	--	24.5	11	1.0	2.0	0.270	100
16	--	ST1717	B	*	11.5	5.8	5.4	--	29.5	15	1.0	2.0	0.390	100
25	--	ST1718	B	*	13.5	6.8	6.7	--	33.5	15	1.2	2.4	0.630	100
35	--	ST1719	B	*	16.0	8.0	8.2	--	40.5	20	1.5	3.2	1.170	50
50	--	ST1720	B	*	19.0	9.5	9.5	--	45.0	20	1.8	3.6	1.790	50
70	--	ST1721	B	*	24.0	11.0	11.2	--	55.0	23	2.0	4.0	2.920	50
95	--	ST1722	B	*	24.0	12.5	13.5	--	55.0	23	2.5	5.0	4.300	50

Insulated solderless terminals for meter connections, Cu, fork type

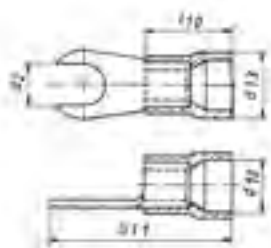

- ▶ For round conductors, e.g. to DIN EN 60228 Cl. 2, 5 and 6
- ▶ Special design for meter connection
- ▶ High-quality brazing process in the crimp area
- ▶ Fast preparation as no additional insulation of the crimped connection is required

Characteristics

- Improved contact properties due to grooved profile
- Cross-section-dependent colour-coding
- Heat resistant to 105° C

Material

- Copper (ETP)
- Insulation sleeve: PA

Surface

- Tin-plated to protect against corrosion

Technical instructions

- Tool: see page 84

Nominal cross section mm ²	Part No.	Colour	Dimension mm					Gewicht 100 St. ~kg Cu	Gewicht 100 St. ~kg Ges.	Packing unit/ pcs
			d12	d13	d2	l11	l10			
10	652C5	■	7.0	9.6	5.3	33.5	19.0	0.24	0.28	100
	652C6	■	7.0	9.6	6.4	33.5	19.0	0.26	0.30	100
16	653C6	■	8.6	10.6	6.4	37.5	20.5	0.35	0.40	100

Solderless connectors to DIN, Cu, short type

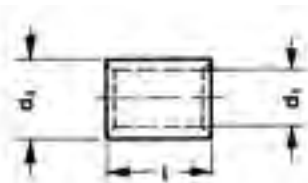

- ▶ For round conductors, e.g. to DIN EN 60228 Cl. 2, 5 and 6
- ▶ To DIN 46341, Part 1, Form A
- ▶ Ideal for connecting differing conductor cross-sections

Characteristics

- Simple cable entry due to internal chamfer
- Annealed material optimises material and crimping properties

Material

- Copper (EN13600)

Surface

- Tin-plated to protect against corrosion

Technical instructions

- Tool: see page 82

Nominal cross section mm ²	Nominal size to DIN	Part No.	Dimension mm			Weight 100 pcs. ~kg	Packing unit/pcs
			d1	d4	l		
0.5 - 1	1	1620K	1.6	3.2	8	0.045	100
1.5 - 2.5	2.5	1630K	2.3	3.9	8	0.055	100
4 - 6	6	1650K	3.6	5.6	9	0.090	100
10	10	1652K	4.5	6.7	10	0.170	100
16	16	1653K	5.8	8.2	11	0.260	100
25	25	1654K	7.5	10.5	14	0.510	100
35	35	1655K	9.0	12.2	16	0.730	100
50	50	1656K	11.0	14.6	19	1.200	100
70	70	1657K	13.0	17.0	19	1.530	50
95	95	1658K	15.0	20.0	20	2.370	50
120	120	1659K	16.5	22.5	22	3.450	50
150	150	1660K	19.0	25.4	26	5.060	50



Solderless connectors to DIN, Cu, long type

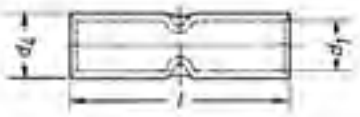

- ▶ For round conductors, e.g. to DIN EN 60228 Cl. 2, 5 and 6
- ▶ To DIN 46341, Part 1, Form B
- ▶ Simple and safe processing due to butt mark



Characteristics

- Simple cable entry due to internal chamfer
- Annealed material optimises material and crimping properties



Material

- Copper (EN13600)



Surface

- Tin-plated to protect against corrosion



Technical instructions

- Tool: see page 82

Nominal cross section mm ²	Nominal size to DIN	Part No.	Dimension mm			Weight 100 pcs. ~kg	Packing unit/pcs
			d1	d4	l		
0.5 - 1	1	1620L	1.6	3.2	15	0.08	100
1.5 - 2.5	2.5	1630L	2.3	3.9	15	0.10	100
4 - 6	6	1650L	3.6	5.6	15	0.19	100
10	10	1652L	4.5	6.7	21	0.36	100
16	16	1653L	5.8	8.2	26	0.62	100
25	25	1654L	7.5	10.5	29	1.11	100
35	35	1655L	9.0	12.2	32	1.50	100
50	50	1656L	11.0	14.6	38	2.44	100
70	70	1657L	13.0	17.0	42	3.54	50
95	95	1658L	15.0	20.0	48	5.87	50
120	120	1659L	16.5	22.5	52	8.46	50
150	150	1660L	19.0	25.4	56	10.86	50

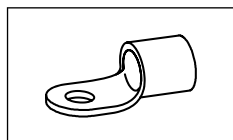

Tool application chart

**Solderless terminals to DIN 46234, pin terminals to DIN 46230,
solderless connectors to DIN 46341**
Part 1 of 2

Tool type	Crimping range corresponds to nominal cross-section mm ²	Crimping Tool		Catalogue page		Crimp profile
		Part No.	Crimping head / adapter	Crimping Tool	Crimping die	
Mechanical crimping tools	0.5-16	K25		230		
	16-95	K95		230		
		TK95		231		
Mechanical, electrical, pneumatic crimping tools with interchangeable dies / heads	0.5-10	K50		244	326	
		EK50ML		254	326	
		K507		243		
	0.75-2.5	KP1	+KP232	240		
		KP1L	+KP232	240		
	4-10	KP1	+KP242	240		
		KP1L	+KP242	240		
	10-35	K354		246	330	
	10-70	K18		248	338	
		K22		250	343	
Hand hydraulic crimping tools	10-70	HK6018		292	338	
		HK60UNV	+UA18	473	338	
		HK6022		294	343	
		HK60UNV	+UA22	473	343	
	16-150	HK12030		298	349	
		HK12042		300	349	
		HK120U		302	349	
Battery powered crimping tools	0.5-10	EK1550ML		258	326	
	0.75-2.5	EKP1ML	+KP232	260		
	4-10	EKP1ML	+KP242	260		
	10-35	EK354ML		262	330	
		EK354		266	330	
	10-50	EK505		268	334	
	10-70	EK5018		270	338	
		EK60UNV	+UA18	476	338	
		EKM60UNV	+UA18	475	338	
		EK6022		247	343	
		EKM6022		272	343	
		EK60UNV	+UA22	476	343	
		EKM60UNV	+UA22	475	343	
	10-240	EKM60ID		278		
	16-150	EK12032		280	349	
		EK12042		282	349	
		EK120U		284	349	
		EK135FT	+UA15T	286	349	
		EK120UNV	+UA12T	477	349	
35-240	EK120ID		279			

see next page

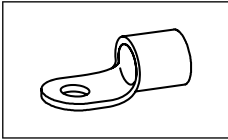

Tool application chart

**Solderless terminals to DIN 46234, pin terminals to DIN 46230,
solderless connectors to DIN 46341**
Part 2 of 2

Tool type	Crimping range corresponds to nominal cross-section mm ²	Crimping Tool		Catalogue page		Crimp profile
		Part No.	Crimping head / adapter	Crimping Tool	Crimping die	
Hydraulic crimping systems	10-70	THK18		306	338	
		THK22		308	343	
	16-150	HK122EL380		322	349	
	16-240	HK252		320	354	
		HK252EL380		323	354	
	Hydraulic crimping heads	10-70	PK18		306	338
PK60UNV			+UA18	474	338	
PK22				308	343	
PK60UNV			+UA22	474	343	
10-240		PK60ID		311		
16-150		PK12042		312	349	
		PK120U		314	349	
16-240		PK252		316	354	

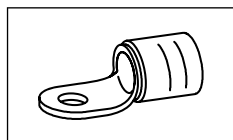

Tool application chart

Isolierte Quetschkabelschuhe Isolierte Stiftkabelschuhe

Tool type	Crimping range corresponds to nominal cross-section mm ²	Crimping Tool		Catalogue page		Crimp profile
		Part No.	Crimping head / adapter	Crimping Tool	Crimping die	
Mechanical crimping tools	10-16	K16		223		○
Mechanical, electrical, pneumatic crimping tools with interchangeable dies / heads	10-16	K50		244	327	○
		EK50ML		254	327	○
		K354		246	327	○
	10-50	K18		248	338	☺
	10-70	K22		250	343	☺
Hand hydraulic crimping tools	10-50	HK6018		292	338	☺
		HK60UNV	+UA18	473	338	☺
	10-70	HK6022		294	343	☺
		HK60UNV	+UA22	473	343	☺
	10-95	HK12030		298	349	☺
		HK12042		300	349	☺
		HK120U		302	349	☺
Battery powered crimping tools	10-16	EK1550ML		258	327	○
		EK354ML		262	330	☺
		EK354		266	330	☺
	10-50	EK5018		270	338	☺
		EK60UNV	+UA18	476	338	☺
		EKM60UNV	+UA18	475	338	☺
	10-70	EK6022		274	343	☺
		EKM6022		272	343	☺
		EK60UNV	+UA22	476	343	☺
		EKM60UNV	+UA22	475	343	☺
	10-95	EK12032		280	349	☺
		EK12042		282	349	☺
		EK120U		284	349	☺
		EK135FT	+UA15T	286	349	☺
		EK120UNV	+UA12T	477	349	☺
	Hydraulic crimping systems	10-50	THK18		306	338
10-70		THK22		308	343	☺
10-150		HK252		320	355	☺
Hydraulic crimping heads	10-50	PK18		306	338	☺
		PK60UNV	+UA18	474	338	☺
	10-70	PK22		308	343	☺
		PK60UNV	+UA22	474	343	☺
	10-95	PK12042		312	349	☺
		PK120U		314	349	☺
10-150	PK252		316	355	☺	



COMPENSATING - SLEEVES FOR COPPER SECTOR-SHAPED AND COMPACTED CONDUCTORS

With the right sleeve, copper sector-shaped conductors are easy to crimp all the way round and can then be conveniently inserted into the cable lug. Klauke sleeves for compacted conductors compensate the difference between the compacted conductor and cable lug - ensuring reliable connections.



In brief

- ▶ For round crimping sector-shaped conductors
- ▶ Brings compacted conductors to the required volume
- ▶ Good conductivity due to high-quality copper
- ▶ Available for DIN and tubular cable lugs



Note: The sleeves for sector-shaped conductors must be crimped with pre-rounding dies.



► **Filled in two steps**

Making it easy for you: Use the Klauke sleeves to bring compacted conductors to the required volume in just two work steps: Simply attach the sleeve to the stripped conductor and insert it into the appropriate cable lug - done.

No additional tools and no special solutions required.

- Simple filling of compacted conductors
- For nominal cross-sections of up to 400 mm²
- High-quality material reduces contact resistance
- No special solutions required: existing tool can be used for reliable crimping

► **Pre-rounded sector-shaped conductors**

Pre-rounds 3- and 4-sector-shaped conductors without special cable lugs - using Klauke sleeves.

- For pre-rounding of sector-shaped conductors
- Suitable for 3- and 4-sector-shaped conductors at angles of 120° and 90°
- Nominal cross-section up to 240 mm²
- No splicing of conductors
- No special cable lugs required
- Lower storage costs

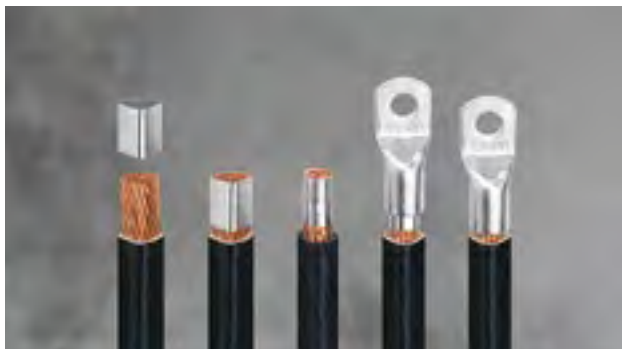

► **The right sleeve for every cable lug**

With Klauke, everything fits together. The diameter and length of the sleeve are adapted to the required cable lug to ensure optimum crimping.

- Reliable crimping in a just a few steps
- Sleeves accurately matched to the Klauke system





Sleeves for compacted conductors, for tubular cable lugs and connector standard type

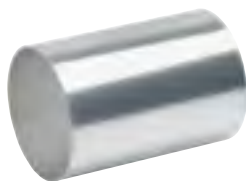

- ▶ For multi-stranded, compacted conductors e.g. to DIN EN 60228 Cl. 2
- ▶ Allows the use of Klauke tubular cable lugs and connectors, standard type, on compacted conductors

Characteristics

- Annealed material optimises material and crimping properties

Material

- Copper (HCP)

Surface

- Tin-plated to protect against corrosion

Technical instructions

- Refer to the installation instructions in the technical appendix on page i-7

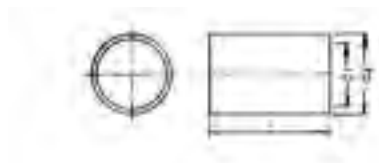

Nominal cross section mm ²	Part No.	Dimension mm			Weight 100 pcs. ~kg	Packing unit/pcs
		d1	d4	l		
16	VHR16	5.0	5.3	11	0.024	100
25	VHR25	6.4	6.7	14	0.038	100
35	VHR35	7.7	8.2	15	0.083	100
50	VHR50	9.0	9.5	18	0.118	50
70	VHR70	10.6	11.2	19	0.173	50
95	VHR95	12.4	13.0	21	0.223	50
120	VHR120	13.9	14.5	22	0.261	50
150	VHR150	15.4	16.0	26	0.342	25
185	VHR185	17.6	18.2	26	0.396	25
240	VHR240	19.9	20.5	30	0.508	25
300	VHR300	22.4	23.0	38	0.723	10
400	VHR400	25.4	26.2	38	1.108	10



Sleeves for compacted conductors, for tubular cable lugs and connector DIN type

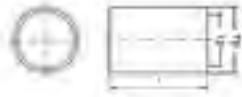

- ▶ For multi-stranded, compacted conductors e.g. to DIN EN 60228 Cl. 2
- ▶ Allows the use of Klauke DIN compression cable lugs and connectors for compacted conductors

Characteristics

- Annealed material optimises material and crimping properties

Material

- Copper (HCP)

Surface

- Tin-plated to protect against corrosion

Technical instructions

- Refer to the installation instructions in the technical appendix on page i-7

Nominal cross section mm ²	Part No.	Dimension mm			Weight 100 pcs. ~kg	Packing unit/pcs
		d1	d4	l		
16	VHD16	5.0	5.3	16	0.035	100
25	VHD25	6.4	6.7	16	0.043	100
35	VHD35	7.7	8.2	17	0.094	100
50	VHD50	9.0	9.5	23	0.151	50
70	VHD70	10.6	11.2	24	0.219	50
95	VHD95	12.4	13.0	28	0.298	50
120	VHD120	13.9	14.5	30	0.357	50
150	VHD150	15.4	16.0	30	0.395	25
185	VHD185	17.6	18.2	38	0.579	25
240	VHD240	19.9	20.5	38	0.645	25
300	VHD300	22.4	23.0	48	0.913	5
400	VHD400	25.4	26.2	58	1.692	5



Sleeves for sector shaped conductors, 3-core cable



- ▶ For multi-stranded, sector shaped conductors, e.g. to DIN EN 60228
- ▶ For tubular cable lugs and connectors, standard version and DIN compression cable lugs and connectors
- ▶ To simplify pre-rounding of 3-core cables (120° angle)
- ▶ Prevents sector shaped conductors from de-stranding during pre-rounding

Characteristics

- Annealed material optimises material and crimping properties

Material

- Copper (HCP)

Surface

- Tin-plated to protect against corrosion

Technical instructions

- For round crimping dies, see „Crimping dies“
- Refer to the installation instructions in the technical appendix on page i-7

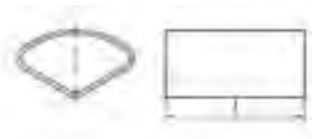

Nominal cross section mm ²	Part No.	Dimension mm für l	Weight 100 pcs. ~kg	Packing unit/pcs
Standard type				
35	VHR353	14	0.08	100
50	VHR503	17	0.17	50
70	VHR703	18	0.29	50
95	VHR953	22	0.45	50
120	VHR1203	23	0.49	50
150	VHR1503	25	0.58	25
185	VHR1853	25	0.80	25
240	VHR2403	30	1.04	25
DIN version				
35	VHD353	17,5	0.11	100
50	VHD503	25,0	0.26	50
70	VHD703	25,0	0.39	50
95	VHD953	32,0	0.66	50
120	VHD1203	32,0	0.68	50
150	VHD1503	32,0	0.74	25
185	VHD1853	35,0	1.13	25
240	VHD2403	35,0	1.22	25



Sleeves for sector shaped conductors, 4-core cable



- ▶ For multi-stranded, sector shaped conductors, e.g. to DIN EN 60228
- ▶ For tubular cable lugs and connectors, standard version and DIN compression cable lugs and connectors
- ▶ To simplify pre-rounding of 4-core cables (90° angle)
- ▶ Prevents sector shaped conductors from de-stranding during pre-rounding

Characteristics

- Annealed material optimises material and crimping properties

Material

- Copper (HCP)

Surface

- Tin-plated to protect against corrosion

Technical instructions

- Refer to the installation instructions in the technical appendix on page i-7
- For round crimping dies, see „Crimping dies“

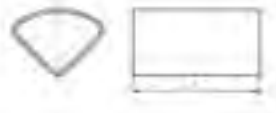

Nominal cross section mm ²	Part No.	Dimension mm für l	Weight 100 pcs. ~kg	Packing unit/pcs
Standard type				
35	VHR354	14	0.13	100
50	VHR504	17	0.17	50
70	VHR704	18	0.28	50
95	VHR954	22	0.40	50
120	VHR1204	23	0.51	50
150	VHR1504	25	0.57	25
185	VHR1854	25	0.78	25
240	VHR2404	30	0.85	25
DIN version				
35	VHD354	17.5	0.11	100
50	VHD504	25.0	0.25	50
70	VHD704	25.0	0.38	50
95	VHD954	32.0	0.63	50
120	VHD1204	32.0	0.71	50
150	VHD1504	32.0	0.73	25
185	VHD1854	35.0	1.09	25
240	VHD2404	35.0	1.13	25

RELIABLE - ALUMINIUM COMPRESSION CABLE LUGS AND CONNECTORS TO DIN

Light and extremely reliable: Klauke aluminium compression cable lugs are both. Contact grease breaks down the oxidation layer, high-quality tinning facilitates the contact with copper in dry environments. For the toughest demands, all cable lugs and most cable lugs and connectors are IEC-tested for safety.

We offer a solution for practically every problem.



In brief

- ▶ Aluminium cable lugs and connectors according to and based on DIN standards
- ▶ Tested to the stringent IEC 61238-1
- ▶ Appropriate solutions to 30 kV
- ▶ Also for power lines and conductor wires
- ▶ Tinned and non-tinned versions available



► Deep drawn

Deep-drawn connectors are produced with barrier and precisely to DIN 46329. Thanks to the special production method, there is absolutely no ingress or escaping of liquids through the cable lug flange.

- Barrier design with oil stop
- Filled with contact grease as standard
- In the tinned version, also suitable for connecting to copper in dry environments
- For moist environments, we recommend Klauke connectors made from aluminium/copper

► Same excellent quality

Because we at Klauke have our own manufacturing facilities, our products are always the same consistently high quality. No matter which cable lug or connector you need, the Klauke system guarantees you the best results.

- Constant qualities in many forms
- Connections according to or based on DIN standards
- Simple processing with DIN hexagonal crimping or optionally EKM60ID
- Guaranteed safety through IEC 61238-1 tests



► Flexibility in power line construction

In power line construction too, Klauke products provide the flexible and reliable solution.

For special solutions, contact us directly. We can make them for you.

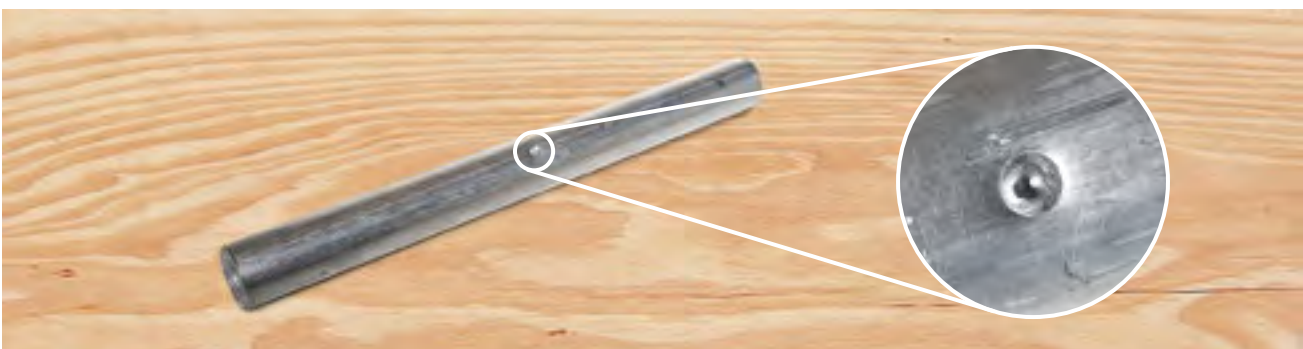



Compression cable lugs to DIN, Al

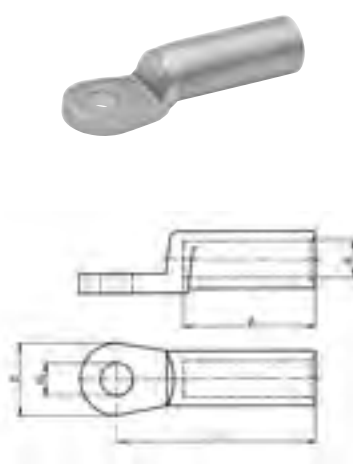

- ▶ For non-tension connections of aluminium conductors to DIN EN 60228 and aluminium cables to DIN EN 50182
- ▶ For pre-rounded sector shaped conductors
- ▶ To DIN 46329
- ▶ Filled with contact grease for optimum crimp characteristics

Characteristics

- Barrier design with oil stop
- Optional tin-plated (20 µm) version to connect copper bus bars in dry indoor areas
- Simple and safe connection due to flat contact surfaces and internal chamfer
- Unique tool assignment due to DIN die coding

Material

- E-aluminium

Surface

- Bright

Technical instructions

- Tool: see page 103

Additional information

- Part Number appendix for tinned version „V“
- re = round single solid wire, rm = round multi-stranded, se = sector shaped single solid wire, sm = sector shaped multi-stranded, sector shaped conductors must be pre-rounded
- 70 - 240 mm² UL-tested
- * = not standardised

Size of bolt dia.	Part No.	Nominal cross section mm ²		Hint	Code	Dimension mm					Number of crimps		Weight 100 pcs. ~kg	Packing unit/pcs
		rm/sm	se			a	b	d1	d2	l	Al (7 mm)	Al (wide)		
M 8	263R8	16	--	*	12	30	20	5.8	8.4	50	4	2	1.20	4
M 10	263R10	16	--	*	12	30	20	5.8	10.5	50	4	2	1.20	4
M 8	264R8	25	--		12	30	25	6.8	8.4	50	4	2	1.30	4
M 10	264R10	25	--		12	30	25	6.8	10.5	50	4	2	1.24	4
M 12	264R12	25	--		12	30	25	6.8	13.0	50	4	2	1.22	4
M 8	265R8	35	50		14	42	25	8.0	8.4	62	5	2	2.50	4
M 10	265R10	35	50		14	42	25	8.0	10.5	62	5	2	1.98	4
M 12	265R12	35	50		14	42	25	8.0	13.0	62	5	2	2.50	4
M 8	266R8	50	70		16	42	25	9.8	8.4	62	5	2	2.75	4
M 10	266R10	50	70		16	42	25	9.8	10.5	62	5	2	2.70	4
M 12	266R12	50	70		16	42	25	9.8	13.0	62	5	2	2.65	4
M 8	267R8	70	95		18	52	25	11.2	8.4	72	6	3	3.45	4
M 10	267R10	70	95		18	52	25	11.2	10.5	72	6	3	3.80	4
M 12	267R12	70	95		18	52	25	11.2	13.0	72	6	3	3.35	4
M 10	268R10	95	120		22	56	25	13.2	10.5	75	6	3	6.90	4
M 12	268R12	95	120		22	56	25	13.2	13.0	75	6	3	4.92	4
M 16	268R16	95	120	*	22	56	25	13.2	17.0	75	6	3	6.00	4
M 10	269R10	120	150		22	56	30	14.7	10.5	80	6	3	5.95	4
M 12	269R12	120	150		22	56	30	14.7	13.0	80	6	3	5.84	4
M 16	269R16	120	150		22	56	30	14.7	17.0	80	6	3	6.60	4
M 10	270R10	150	185		25	60	30	16.3	10.5	90	6	3	8.50	4

See next page



Compression cable lugs to DIN, Al

Size of bolt dia.	Part No.	Nominal cross section mm ²		Hint	Code	Dimension mm					Number of crimps		Weight 100 pcs. ~kg	Packing unit/pcs
		rm/sm	se			a	b	d1	d2	l	Al (7 mm)	Al (wide)		
M 12	270R12	150	185		25	60	30	16.3	13.0	90	6	3	7.73	4
M 16	270R16	150	185		25	60	30	16.3	17.0	90	6	3	7.60	4
M 20	270R20	150	185	*	25	60	30	16.3	21.0	90	6	3	8.20	4
M 10	271R10	185	240		28	60	30	18.3	10.5	91	6	3	11.00	4
M 12	271R12	185	240		28	60	30	18.3	13.0	91	6	3	9.88	4
M 16	271R16	185	240		28	60	30	18.3	17.0	91	6	3	10.10	4
M 20	271R20	185	240	*	28	60	30	18.3	21.0	91	6	3	10.00	4
M 10	272R10	240	300	*	32	70	38	21.0	10.5	103	8	3	15.50	4
M 12	272R12	240	300		32	70	38	21.0	13.0	103	8	3	13.80	4
M 16	272R16	240	300		32	70	38	21.0	17.0	103	8	3	13.48	4
M 20	272R20	240	300		32	70	38	21.0	21.0	103	8	3	15.00	4
M 12	273R12	300	--		34	70	38	23.3	13.0	103	8	3	17.60	1
M 16	273R16	300	--		34	70	38	23.3	17.0	103	8	3	17.28	1
M 20	273R20	300	--		34	70	38	23.3	21.0	103	8	3	17.40	1
M 12	274R12	400	--		38	73	38	26.0	13.0	116	--	4	38.00	1
M 16	274R16	400	--		38	73	38	26.0	17.0	116	--	4	37.40	1
M 20	274R20	400	--		38	73	38	26.0	21.0	116	--	4	40.20	1
M 12	275R12	500	--		44	79	44	29.0	13.0	122	--	4	43.70	1
M 16	275R16	500	--		44	79	44	29.0	17.0	122	--	4	43.30	1
M 20	275R20	500	--		44	79	44	29.0	21.0	122	--	4	43.00	1



Compression cable lugs, Al

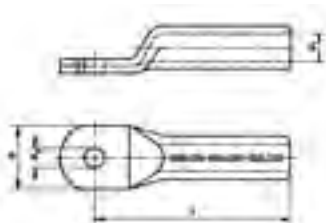

- ▶ For non-tension connections of aluminium conductors to DIN EN 60228 and aluminium cables to DIN EN 50182
- ▶ For pre-rounded sector shaped conductors
- ▶ Tube dimension to DIN 46329
- ▶ With code number for clear tool assignment
- ▶ Filled with contact grease for optimum crimp characteristics

Characteristics

- Easy to process due to crimp markings
- Simple and safe connection due to flat contact surfaces and internal chamfer

Material

- E-aluminium

Surface

- Bright

Technical instructions

- Tool: see page 103

Additional information

- re = round single solid wire, rm = round multi-stranded, se = sector shaped single solid wire, sm = sector shaped multi-stranded, sector shaped conductors must be pre-rounded
- 16 - 400 mm² IEC-tested

Size of bolt dia.	Part No.	Nominal cross section mm ²		Code	Dimension mm				Number of crimps		Weight 100 pcs. ~kg	Packing unit/pcs
		rm/sm	se		b	d1	d2	l	Al (7 mm)	Al (wide)		
M 6	202R6	10	--	10	16	5.0	6.5	52	4	2	0.86	25
M 8	202R8	10	--	10	18	5.0	8.5	52	4	2	0.88	25
	203R8	16	--	12	18	5.8	8.5	52	4	2	1.37	10
M 10	203R10	16	--	12	18	5.8	10.5	52	4	2	1.39	10
M 8	204R8	25	--	12	18	6.8	8.5	60	4	2	1.41	10
M 10	204R10	25	--	12	18	6.8	10.5	60	4	2	1.46	10
	205R10	35	50	14	21	8.0	10.5	67	5	2	2.08	10
M 12	205R12	35	50	14	21	8.0	13.0	67	5	2	2.05	10
M 10	206R10	50	70	16	25	9.8	10.5	72	5	2	2.68	10
M 12	206R12	50	70	16	25	9.8	13.0	72	5	2	2.73	10
M 10	207R10	70	95	18	28	11.2	10.5	86	6	3	4.42	10
M 12	207R12	70	95	18	28	11.2	13.0	86	6	3	4.27	10
M 10	208R10	95	120	22	32	13.2	10.5	90	6	3	7.40	4
M 12	208R12	95	120	22	32	13.2	13.0	90	6	3	7.50	4
M 16	208R16	95	120	22	34	13.2	17.0	90	6	3	7.30	4
M 12	209R12	120	150	22	32	14.7	13.0	91	6	3	6.68	4
M 16	209R16	120	150	22	34	14.7	17.0	91	6	3	6.41	4
M 12	210R12	150	185	25	35	16.3	13.0	103	6	3	9.64	4
M 16	210R16	150	185	25	35	16.3	17.0	103	6	3	9.24	4
M 20	210R20	150	185	25	41	16.3	21.0	103	6	3	9.40	4
M 12	211R12	185	240	28	40	18.3	13.0	106	6	3	12.61	1
M 16	211R16	185	240	28	40	18.3	17.0	106	6	3	11.92	1
M 20	211R20	185	240	28	40	18.3	21.0	106	6	3	13.10	1
M 12	212R12	240	300	32	45	21.0	13.0	116	8	3	18.30	1
M 16	212R16	240	300	32	45	21.0	17.0	116	8	3	17.60	1
M 20	212R20	240	300	32	45	21.0	21.0	116	8	3	17.30	1
M 16	213R16	300	--	34	49	23.3	17.0	124	8	3	17.50	1
M 20	213R20	300	--	34	49	23.3	21.0	124	8	3	17.30	1
M 16	214R16	400	--	38	58	26.0	17.0	165	--	4	32.20	1
M 20	214R20	400	--	38	58	26.0	21.0	165	--	4	31.90	1



Compression joint to DIN, Al

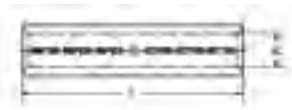

- ▶ For non-tension connections of aluminium conductors to DIN EN 60228 and aluminium cables to DIN EN 50182
- ▶ To DIN 46267, Part 2
- ▶ With code number for clear tool assignment
- ▶ Filled with contact grease for optimum crimp characteristics
- ▶ For pre-rounded sector shaped conductors

Characteristics

- Easy to process due to crimp markings
- Simple cable entry due to internal chamfer
- Simple and safe processing due to butt mark

Material

- E-aluminium

Surface

- Bright

Technical instructions

- Tool: see page 103

Additional information

- re = round single solid wire, rm = round multi-stranded, se = sector shaped single solid wire, sm = sector shaped multi-stranded, sector shaped conductors must be pre-rounded
- 16 - 500 mm² IEC-tested
- * = not standardised

Part No.	Nominal cross section mm ²		Hint	Code	Dimension mm		Number of crimps		Weight 100 pcs. ~kg	Packing unit/ pcs
	rm/sm	se			d1	l	Al (7 mm)	Al (wide)		
222R	10	--	*	10	5.0	55	3/3	--	0.95	10
223R	16	--	*	12	5.8	55	3/3	--	1.40	10
224R	25	--		12	6.8	70	4/4	2/2	1.60	10
225R	35	50		14	8.0	85	5/5	2/2	2.60	10
226R	50	70		16	9.8	85	5/5	2/2	3.20	10
227R	70	95		18	11.2	105	6/6	3/3	5.30	10
228R	95	120		22	13.2	105	6/6	3/3	7.60	10
229R	120	150		22	14.7	105	6/6	3/3	7.80	10
230R	150	185		25	16.3	125	6/6	3/3	10.70	10
231R	185	240		28	18.3	125	6/6	3/3	14.30	5
232R	240	300		32	21.0	145	8/8	3/3	20.30	5
233R	300	--		34	23.3	145	8/8	3/3	22.20	1
234R	400	--		38	26.0	210	--	5/5	40.80	1
235R	500	--		44	29.0	210	--	5/5	56.00	1



Compression joints, Al

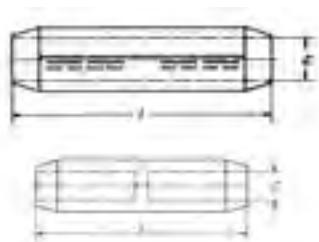

- ▶ For non-tension connections of medium-voltage aluminium cable 10-30 kV
- ▶ For non-tension connections of aluminium conductors to DIN EN 60228 and aluminium cables to DIN EN 50182 and pre-rounded sector shaped conductors
- ▶ Tube dimension to DIN 46267, Part 2
- ▶ With code number for clear tool assignment
- ▶ Filled with contact grease for optimum crimp characteristics

Characteristics

- Also available as barrier design with oil stop
- With chamfered edges for reduced wrapping during assembly
- Easy to process due to crimp markings
- Simple cable entry due to internal chamfer

Material

- E-aluminium

Surface

- Bright

Technical instructions

- Tool: see page 103

Additional information

- re = round single solid wire, rm = round multi-stranded, se = sector shaped single solid wire, sm = sector shaped multi-stranded, sector shaped conductors must be pre-rounded

Part No.	Nominal cross section mm ²		Code	Dimension mm		Number of crimps		Weight 100 pcs. ~kg	Packing unit/ pcs
	rm/sm	se		d1	l	Al (7 mm)	Al (wide)		
Standard type									
405R	35	50	14	8.20	90	4/4	2/2	2.7	10
406R	50	70	16	10.00	90	4/4	2/2	3.4	10
407R	70	95	18	11.50	95	4/4	2/2	4.6	10
408R	95	120	22	13.50	100	4/4	2/2	6.8	10
409R	120	150	22	15.00	105	4/4	2/2	7.4	10
410R	150	185	25	16.50	105	4/4	2/2	8.7	10
411R	185	240	28	18.50	125	5/5	2/2	13.4	5
412R	240	300	32	21.30	125	5/5	2/2	15.7	5
413R	300	--	34	23.60	125	5/5	2/2	16.3	1
414R	400	--	38	26.25	150	--	3/3	25.8	1
Barrier version									
415R	35	50	14	8.0	95	4/4	2/2	3.1	5
416R	50	70	16	9.8	95	4/4	2/2	5.6	5
417R	70	95	18	11.2	100	4/4	2/2	6.1	5
418R	95	120	22	13.2	105	4/4	2/2	9.2	5
419R	120	150	22	14.7	110	4/4	2/2	10.3	5
420R	150	185	25	16.3	110	4/4	2/2	12.0	5
421R	185	240	28	18.3	130	5/5	2/2	15.6	5
422R	240	300	32	21.0	130	5/5	2/2	19.1	5
423R	300	--	34	23.3	135	5/5	2/2	30.7	1
424R	400	--	38	26.0	165	--	3/3	30.0	1



Reduction compression joints, Al, barrier type



- ▶ For non-tension connections of aluminium conductors to DIN EN 60228 and aluminium cables to DIN EN 50182
- ▶ In nominal cross-section area tube dimension to DIN 46267, part 2
- ▶ For pre-rounded sector shaped conductors
- ▶ Ideal for connecting differing conductor cross-sections
- ▶ Filled with contact grease for optimum crimp characteristics

Characteristics

- Barrier design with oil stop
- Unique tool assignment due to DIN die coding
- Easy to process due to crimp markings
- Simple cable entry due to internal chamfer

Material

- E-aluminium

Surface

- Bright

Technical instructions

- Tools: see chart page 103

Additional information

- re = round single solid wire, rm = round multi-stranded, se = sector shaped single solid wire, sm = sector shaped multi-stranded, sector shaped conductors must be pre-rounded

Part No.	Nominal cross section mm ²		Code	Dimension mm			Number of crimps		Weight 100 pcs. ~kg	Packing unit/pcs
	von	auf		d1	d2	l	Al (7 mm)	Al (wide)		
425R25	35	25	14	8.0	6.8	95	4/4	2/2	2.800	5
426R35	50	35	16	9.8	8.0	95	4/4	2/2	3.450	5
427R35	70	35	18	11.2	8.0	100	4/4	2/2	4.790	5
427R50	70	50	18	11.2	9.8	100	4/4	2/2	4.420	5
428R50	95	50	22	13.2	9.8	105	4/4	2/2	7.600	5
428R70	95	70	22	13.2	11.2	105	4/4	2/2	7.350	5
429R70	120	70	22	14.7	11.2	110	4/4	2/2	7.100	5
429R95	120	95	22	14.7	13.2	110	4/4	2/2	6.550	5
430R70	150	70	25	16.3	11.2	110	4/4	2/2	9.800	5
430R95	150	95	25	16.3	13.2	110	4/4	2/2	9.500	5
430R120	150	120	25	16.3	14.7	110	4/4	2/2	8.650	5
431R70	185	70	28	18.3	11.2	130	--	2/2	15.050	5
431R95	185	95	28	18.3	13.2	130	--	2/2	14.400	5
431R120	185	120	28	18.3	14.7	130	5/5	2/2	13.700	5
431R150	185	150	28	18.3	16.3	130	5/5	2/2	13.050	5
432R120	240	120	32	21.0	14.7	130	--	2/2	18.800	5
432R150	240	150	32	21.0	16.3	130	5/5	2/2	18.125	5
432R185	240	185	32	21.0	18.3	130	5/5	2/2	17.275	5
433R150	300	150	34	23.3	16.3	135	5/5	2/2	21.100	1
433R185	300	185	34	23.3	18.3	135	5/5	2/2	20.120	1
433R240	300	240	34	23.3	21.0	135	5/5	2/2	18.730	1
434R300	400	300	38	26.0	23.3	165	--	3/3	31.200	1



Reduction-compression joints, Al



- ▶ For non-tension connections of aluminium conductors to DIN EN 60228 and aluminium cables to DIN EN 50182
- ▶ For pre-rounded sector shaped conductors
- ▶ In nominal cross-section area tube dimension to DIN 46267, part 2
- ▶ With code number for clear tool assignment
- ▶ Filled with contact grease for optimum crimp characteristics

Characteristics

- For connecting different conductor cross-sections
- Easy to process due to crimp markings
- Simple cable entry due to internal chamfer

Material

- E-aluminium

Surface

- Bright

Technical instructions

- Tool: see page 103

Additional information

- re = round single solid wire, rm = round multi-stranded, se = sector shaped single solid wire, sm = sector shaped multi-stranded, sector shaped conductors must be pre-rounded

Part No.	Nominal cross section mm ²		Code	Dimension mm			Number of crimps		Weight 100 pcs. ~kg	Packing unit/pcs
	von	auf		d1	d2	l	Al (7 mm)	Al (wide)		
284R16	25	16	12	7.0	5.8	75	4/4	2/2	1.53	10
285R25	35	25	14	8.2	6.8	90	5/5	2/2	2.50	10
286R25	50	25	16	10.0	6.8	90	5/5	2/2	3.24	10
286R35	50	35	16	10.0	8.0	90	5/5	2/2	3.09	10
287R25	70	25	18	11.5	6.8	110	6/6	3/3	5.50	10
287R35	70	35	18	11.5	8.0	110	6/6	3/3	5.35	10
287R50	70	50	18	11.5	9.8	110	6/6	3/3	4.96	10
288R25	95	25	22	13.5	6.8	110	6/6	3/3	9.10	10
288R35	95	35	22	13.5	8.0	110	6/6	3/3	8.90	10
288R50	95	50	22	13.5	9.8	110	6/6	3/3	8.51	10
288R70	95	70	22	13.5	11.2	110	6/6	3/3	8.15	10
289R50	120	50	22	15.0	9.8	110	6/6	3/3	8.04	10
289R70	120	70	22	15.0	11.2	110	6/6	3/3	7.66	10
289R95	120	95	22	15.0	13.2	110	6/6	3/3	7.14	10
290R70	150	70	25	16.5	11.2	130	6/6	3/3	11.70	10
290R95	150	95	25	16.5	13.2	130	6/6	3/3	11.05	10
290R120	150	120	25	16.5	14.7	130	6/6	3/3	10.49	10
291R120	185	120	28	18.5	14.7	130	6/6	3/3	13.80	5
291R150	185	150	28	18.5	16.3	130	6/6	3/3	13.19	5
292R95	240	95	32	21.3	13.2	150	--	3/3	22.24	5
292R120	240	120	32	21.3	14.7	150	--	3/3	21.59	5
292R150	240	150	32	21.3	16.3	150	--	3/3	20.87	5



Compression joint to DIN, Al, full tension



- ▶ For full tension connections of aluminium cables to DIN EN 50182
- ▶ To DIN 48085, Part 2
- ▶ With code number for clear tool assignment
- ▶ Filled with contact grease for optimum crimp characteristics

Characteristics

- Easy to process due to crimp markings
- Simple cable entry due to internal chamfer

Material

- E-aluminium to 95 mm²
- AlMgSi from 120 mm²

Surface

- Bright

Technical instructions

- Tool: see page 103

Additional information

- * = not standardised

Nominal cross section mm ²	Part No.	Hint	Code	Dimension mm			Number of crimps		Conductor mm dia.	Weight 100 pcs. ~kg	Packing unit/pcs
				d1	d4	l	Al (7 mm)	Al (wide)			
16	243R	*	12	5.8	12.0	140	8/8	4/4	5.1	3.4	10
25	244R		12	6.8	12.0	140	8/8	4/4	6.3	2.9	10
35	245R		14	8.0	14.0	140	8/8	4/4	7.5	3.9	10
50	246R		16	10.0	16.0	155	8/8	4/4	9.0	5.2	10
70	247R		18	11.5	18.5	165	8/8	4/4	10.5	7.4	10
95	248R		22	13.5	22.0	165	8/8	4/4	12.5	12.2	10
120	249R		25	15.5	25.5	250	12/12	6/6	14.0	21.8	10
150	250R		28	16.5	28.5	300	--	7/7	15.7	34.4	10
185	251R		28	18.5	28.5	330	--	7/7	17.5	33.0	5
240	252R		34	21.5	34.5	350	--	7/7	20.2	54.0	5
300	253R		38	23.5	38.5	400	--	8/8	22.5	79.0	1



Compression joints, Al, full tension

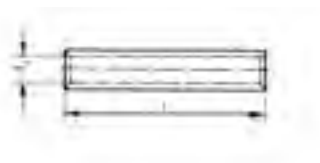

- ▶ For full tension connections of Aldrey cables according to DIN EN 50182
- ▶ With code number for clear tool assignment
- ▶ Filled with contact grease for optimum crimp characteristics

Characteristics

- Tube diameters adjusted to Aldrey cables
- Easy to process due to crimp markings

Material

- AlMgSi F20

Surface

- Bright

Technical instructions

- Tool: see page 103

Nominal cross section mm ²	Part No.	Code	Dimension mm		Number of crimps		Conductor mm dia.	Weight 100 pcs. ~kg	Packing unit/ pcs
			d1	l	Aldrey (7 mm)	Aldrey (wide)			
35	295AD	14	8.0	140	8/8	--	7.5	4.7	5
50	296AD	16	10.0	155	8/8	--	9.0	5.9	5
70	297AD	18	11.5	165	8/8	--	10.5	9.0	5

Compression joint to DIN, Al/St

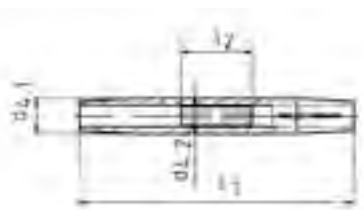

- ▶ For full tension connections of Al/St conductors to DIN EN 50182
- ▶ To DIN 48085, Part 3
- ▶ Unique tool assignment due to coding
- ▶ Filled with contact grease for optimum crimp characteristics

Characteristics

- Easy to process due to crimp markings
- Simple cable entry due to internal chamfer

Material

- Sleeve: E-aluminium
- Sleeve: Steel (St 52)

Surface

- Al sleeve: bright
- St sleeve: hot zinc galvanised

Technical instructions

- Tool: see page 105

Nominal cross section mm ²	Part No.	Code	Dimension mm				Code Al	Number of crimps				Conductor mm dia.	Weight 100 pcs. ~kg	Packing unit/ pcs
			d41	d42	l1	l2		Stahl (5 mm)	Stahl (wide)	Al (7 mm)	Al (wide)			
35 - 6	455R	6	14.0	6.3	235	75	14	5/5	--	8/8	--	8.1	7	5
50 - 8	456R	7	16.0	7.5	270	95	16	6/6	--	9/9	--	9.6	11	5
70 - 12	457R	9	18.5	9.5	270	95	18	6/6	--	9/9	--	11.7	15	5
95 - 15	458R	9	22.5	9.6	310	95	22	6/6	--	11/11	--	13.6	23	5
120 - 20	459R	13	25.0	13.0	380	110	25	7/7	4/4	13/13	6/6	15.5	36	5

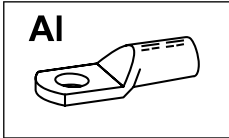

Tool application chart

Compression cable lugs and connectors made from E-AI

Compression cable lugs for full-tension connections from AI conductors DIN EN 50182, 16-95 mm²

Tool type	Crimping range corresponds to nominal cross-section mm ²	Crimping Tool		Catalogue page		Crimp profile
		Part No.	Crimping head / adapter	Crimping Tool	Crimping die	
Mechanical, electrical, pneumatic crimping tools with interchangeable die / head	10-70	K354		246	331	⬡
	10-185	K18		248	339	⬡
	10-240	K22		250	344	⬡
Hand hydraulic crimping tools	10-185	HK6018		292	339	⬡
		HK60UNV	+UA18	473	339	⬡
	10-300	HK6022		294	344	⬡
		HK60UNV	+UA22	473	344	⬡
		HK12030		298	350	⬡
		HK12042		300	350	⬡
		HK120U		302	350	⬡
	150-500	HK45		321	358	⬡
Battery powered crimping tools	10-70	EK354ML		262	331	⬡
		EK354		266	331	⬡
	10-150	EK505		268	335	⬡
	10-185	EK5018		270	339	⬡
		EK60UNV	+UA18	476	339	⬡
		EKM60UNV	+UA18	475	339	⬡
	10-300	EK6022		274	344	⬡
		EKM6022		272	344	⬡
	50-240	EKM60ID*		278		⬡
		EK60UNV	+UA22	476	344	⬡
		EKM60UNV	+UA22	475	344	⬡
		EK120UNV		477	350	⬡
		EK12032		280	350	⬡
		EK12042		282	350	⬡
		EK120U	+UA15T	284	350	⬡
	EK135FT	+UA12T	286	350	⬡	
Hydraulic crimping systems	10-185	THK18		306	339	⬡
	10-300	THK22		308	344	⬡
		HK122EL380		322	350	⬡
	10-500	HK252		320	355	⬡
		HK252EL380		323	355	⬡
Hydraulic crimping heads	10-185	PK18		306	339	⬡
		PK60UNV	+UA18	474	339	⬡
	10-300	PK22		308	344	⬡
		PK60UNV	+UA22	474	344	⬡
		PK12042		312	350	⬡
		PK120U		314	350	⬡
	10-500	PK252		316	355	⬡
	50-240	PK60ID*		311		⬡
	150-500	PK45		318	358	⬡

* Not suitable for full-tension connections

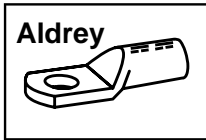

Tool application chart

Compression joints for full-tension connections from Aldrey conductors to DIN EN 50182 and Al conductors to DIN EN 50182, 120-300 mm²

Tool type	Crimping range corresponds to nominal cross-section mm ²	Crimping Tool		Catalogue page		Crimp profile
		Part No.	Crimping head / adapter	Crimping Tool	Crimping die	
Mechanical, electrical, pneumatic crimping tools with interchangeable die / head	25-50	K354		246	331	⬡
	25-95	K18		248	339	⬡
	25-185	K22		250	344	⬡
Hand hydraulic crimping tools	25-95	HK6018		292	339	⬡
		HK60UNV	+UA18	473	339	⬡
	25-185	HK6022		294	344	⬡
		HK60UNV	+UA22	473	344	⬡
		HK12030		298	350	⬡
		HK12042		300	350	⬡
	150-300	HK120U		302	350	⬡
		HK45		321	358	⬡
Battery powered crimping tools	25-50	EK354ML		262	331	⬡
		EK354		266	331	⬡
	25-95	EK505		268	335	⬡
		EK5018		270	339	⬡
		EK60UNV	+UA18	476	339	⬡
		EKM60UNV	+UA18	475	339	⬡
	25-185	EK6022		274	344	⬡
		EKM6022		272	344	⬡
		EK60UNV	+UA22	476	344	⬡
		EKM60UNV	+UA22	475	344	⬡
		EK12032		280	350	⬡
		EK12042		282	350	⬡
		EK120U		284	350	⬡
		EK135FT	+UA15T	286	350	⬡
		EK120UNV	+UA12T	477	350	⬡
Hydraulic crimping systems	25-95	THK18		306	339	⬡
	25-185	THK22		308	344	⬡
		HK122EL380		322	350	⬡
	25-300	HK252		320	355	⬡
		HK252EL380		323	355	⬡
Hydraulic crimping heads	25-95	PK18		306	339	⬡
		PK60UNV	+UA18	474	339	⬡
	25-185	PK22		308	344	⬡
		PK60UNV	+UA22	474	344	⬡
		PK12042		312	350	⬡
		PK120U		314	350	⬡
	25-300	PK252		316	355	⬡
	150-300	PK45		318	358	⬡

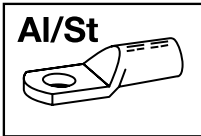

Tool application chart

Compression joints for non-tension connections from Al/St. cables and full-tension connections to DIN 48085, part 3 for Al/St. cables to DIN EN 50182

Tool type	Crimping range corresponds to nominal cross-section mm ²	Crimping Tool		Catalogue page		Crimp profile
		Part No.	Crimping head / adapter	Crimping Tool	Crimping die	
Mechanical, electrical, pneumatic crimping tools with interchangeable die / head	25/4-120/20	K22		250	345	⬡
Hand hydraulic crimping tools	25/4-120/20	HK6022		294	345	⬡
		HK60UNV	+UA22	473	345	⬡
		HK12030		298	350	⬡
		HK12042		300	350	⬡
		HK120U		302	350	⬡
Battery powered crimping tools	25/4-120/20	EK6022		274	345	⬡
		EKM6022		272	345	⬡
		EK60UNV	+UA22	476	345	⬡
		EKM60UNV	+UA22	475	345	⬡
		EK12032		280	350	⬡
		EK12042		282	350	⬡
		EK120U		284	350	⬡
		EK135FT	+UA15T	286	350	⬡
		EK120UNV	+UA12T	477	350	⬡
Hydraulic crimping systems	25/4-120/20	THK22		308	345	⬡
		HK122EL380		322	350	⬡
		HK252		320	356	⬡
		HK252EL380		323	356	⬡
Hydraulic crimping heads	25/4-120/20	PK22		308	345	⬡
		PK60UNV	+UA22	474	345	⬡
		PK12042		312	350	⬡
		PK120U		314	350	⬡
		PK252		316	356	⬡

CONNECTED - COMPRESSION CABLE LUGS MADE FROM ALUMINIUM AND COPPER

Two components reliably connected. Copper and aluminium have different material properties. That's not always a good thing. Our compression cable lugs and connectors made from aluminium and copper are intricately produced by special processes and join together what belongs together. No matter which material you use: Your contacts are reliable with Klauke.



In brief

- ▶ Simple processing based on DIN standards
- ▶ Reliable connection of copper and aluminium, even in contact with water
- ▶ Special manufacturing methods ensure high quality
- ▶ Also suitable for sector shaped conductors and wires



▶ As good as always

Cable lugs and connectors made from aluminium and copper can be processed in exactly the same way as DIN standard aluminium cable lugs. No special tools are required, you simply use the right Klauke dies. And so the result is as good as always.

- For round and sector shaped conductors to DIN EN 60228 and aluminium wires to DIN 50182
- No additional costs for new crimping dies
- Reliable connection by preventing contact corrosion

▶ Numerous versions available

The great thing about the broad Klauke range is: You can select the suitable cable lug for your project and optimally process your choice using the Klauke tools. Everything fitting together.

- Processing as usual with standard aluminium cable lugs
- Different versions available, for instance, as a cable lug with a copper eye or Cupal washers or as a rotational friction welded cable lug



▶ Well connected in every situation

Reduction compression joints enable aluminium conductors to be integrated into copper-containing systems. They connect the two different materials regardless of the physical cable dimensions.

- Suitable for round or sector shaped conductors
- Suitable for multi-stranded and single-stranded sector shaped conductors

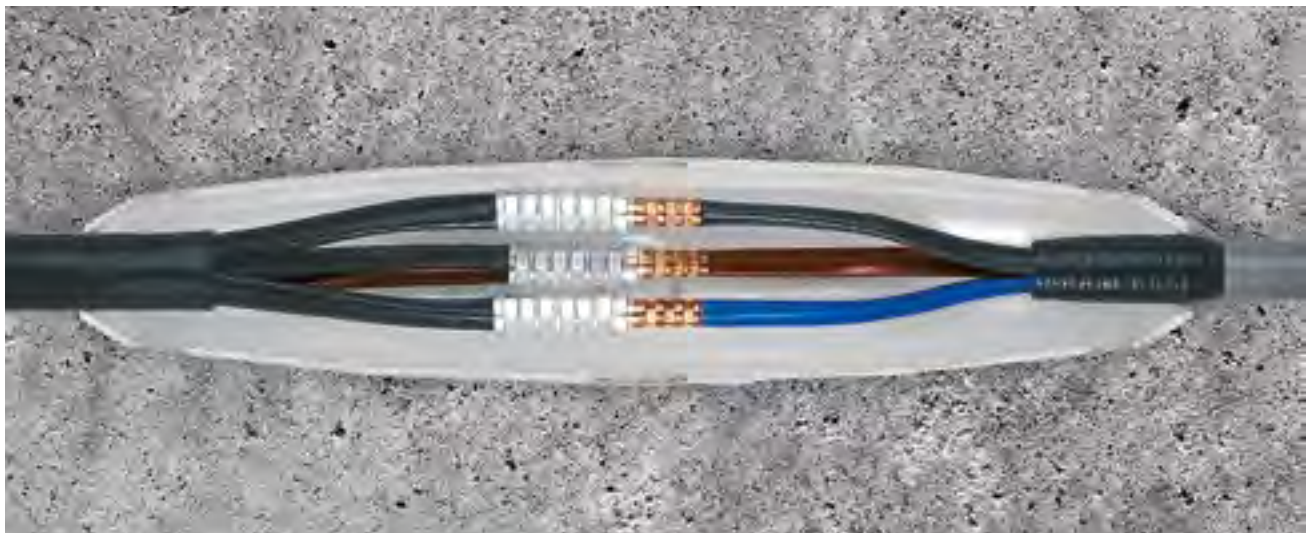



Compression cable lugs, Al/Cu

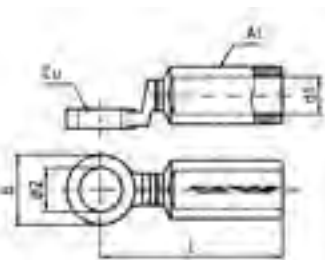

- ▶ Tube dimension to DIN 46329
- ▶ For non-tension connections of Al cables to DIN EN 60228 and aluminium cables to DIN EN 50182 as well as pre-rounded sector shaped conductors
- ▶ For connecting aluminium connections to copper rails in humid areas
- ▶ With code number for clear tool assignment
- ▶ Filled with contact grease for optimum crimp characteristics

Characteristics

- Barrier design with oil stop and solid copper palm
- Easy to process due to crimp markings
- Internal chamfer for simple cable insertion

Suitable for

- Pre-rounded sector shaped conductors

Material

- E-aluminium
- Copper (EN13600)

Surface

- Bright

Technical instructions

- Tool: see page 115

Additional information

- re = round single solid wire, rm = round multi-stranded, se = sector shaped single solid wire, sm = sector shaped multi-stranded, sector shaped conductors must be pre-rounded

Size of bolt dia.	Part No.	Nominal cross section mm ²		Code	Dimension mm				Number of crimps		Weight 100 St. ~kg Cu	Weight 100 St. ~kg total	Packing unit/pcs
		rm/sm	se		b	d1	d2	l	Al (7 mm)	Al (wide)			
M 8	363R8	16		12	25	6.0	8.5	67.5	4	2	4.4	5.9	10
M 10	363R10	16		12	25	6.0	10.5	67.5	4	2	4.2	5.7	10
M 8	364R8	25		12	25	6.8	8.5	67.5	4	2	4.4	5.8	10
M 10	364R10	25		12	25	6.8	10.5	67.5	4	2	4.2	5.6	10
M 12	364R12	25		12	25	6.8	13.0	67.5	4	2	3.9	5.3	10
M 8	365R8	35	50	14	25	8.0	8.5	76.5	5	2	4.4	6.3	10
M 10	365R10	35	50	14	25	8.0	10.5	76.5	5	2	4.2	6.1	10
M 12	365R12	35	50	14	25	8.0	13.0	76.5	5	2	3.8	5.8	10
M 8	366R8	50	70	16	25	9.8	8.5	76.5	5	2	4.4	6.4	10
M 10	366R10	50	70	16	25	9.8	10.5	76.5	5	2	4.2	6.2	10
M 12	366R12	50	70	16	25	9.8	13.0	76.5	5	2	3.9	5.9	10
M 10	367R10	70	95	18	25	11.2	10.5	84.5	6	3	4.2	7.4	10
M 12	367R12	70	95	18	25	11.2	13.0	84.5	6	3	3.9	7.1	10
M 10	368R10	95	120	22	30	13.2	10.5	90.5	6	3	7.4	11.4	10
M 12	368R12	95	120	22	30	13.2	13.0	90.5	6	3	6.8	10.8	10
M 16	368R16	95	120	22	30	13.2	17.0	90.5	6	3	6.4	10.4	10
M 12	369R12	120	150	22	30	14.7	13.0	92.0	6	3	6.8	11.4	5
M 16	369R16	120	150	22	30	14.7	17.0	92.0	6	3	6.4	10.8	5
M 12	370R12	150	185	25	30	16.3	13.0	104.0	6	3	6.8	13.1	5
M 16	370R16	150	185	25	30	16.3	17.0	104.0	6	3	6.4	12.7	5
M 20	370R20	150	185	25	35	16.3	21.0	107.5	6	3	10.1	16.4	5
M 10	371R10	185	240	28	30	18.3	10.5	105.0	6	3	10.3	18.6	5
M 12	371R12	185	240	28	35	18.3	13.0	105.0	6	3	10.1	18.4	5
M 16	371R16	185	240	28	30	18.3	17.0	105.0	6	3	9.3	17.6	5

see next page

Compression cable lugs, Al/Cu

Size of bolt dia.	Part No.	Nominal cross section mm ²			Dimension mm				Number of crimps		Weight 100 St. ~kg Cu	Weight 100 St. ~kg total	Packing unit/pcs
		rm/sm	se	Code	b	d1	d2	l	Al (7 mm)	Al (wide)			
M 20	371R20	185	240	28	35	18.3	21.0	107.5	6	3	10.1	18.4	5
M 10	372R10	240	300	32	35	21.0	10.5	118.5	8	3	12.1	22.5	5
M 12	372R12	240	300	32	35	21.0	13.0	118.5	8	3	11.8	22.2	5
M 16	372R16	240	300	32	35	21.0	17.0	118.5	8	3	11.0	21.4	5
M 20	372R20	240	300	32	35	21.0	21.0	118.5	8	3	10.1	20.5	5
M 12	373R12	300	--	34	40	23.3	13.0	123.5	8	3	17.7	33.7	2
M 16	373R16	300	--	34	40	23.3	17.0	123.5	8	3	16.9	32.9	2
M 20	373R20	300	--	34	40	23.3	21.0	123.5	8	3	16.0	32.0	1
M 12	374R12	400	--	38	40	26.0	13.0	150.5	--	4	25.6	37.4	1

Compression cable lugs, Al/Cu with Cu eye



- ▶ For non-tension connections of aluminium conductors to DIN EN 60228 and aluminium cables to DIN EN 50182
- ▶ Tube dimension to DIN 46329
- ▶ For pre-rounded sector shaped conductors
- ▶ Unique tool assignment due to coding
- ▶ Filled with contact grease for optimum crimp characteristics

Characteristics

- For connecting non-tension aluminium connections using Cu-washers in humid areas
- With Cu eyelet in screw-on area
- Easy to process due to crimp markings
- Simple cable entry due to internal chamfer

Material

- E-aluminium
- Copper (EN13600)

Surface

- Bright

Technical instructions

- Tool: see page 115

Additional information

- re = round single solid wire, rm = round multi-stranded, se = sector shaped single solid wire, sm = sector shaped multi-stranded, sector shaped conductors must be pre-rounded

Size of bolt dia.	Part No.	Nominal cross section mm ²			Dimension mm				Number of crimps		Weight 100 St. ~kg Cu	Weight 100 St. ~kg total	Packing unit/pcs
		rm/sm	se	Code	b	d1	d2	l	Cu (5 mm)	Cu (wide)			
M 6	302R6	10	--	10	18	5.0	6.5	52	4	2	0.260	1.20	10
M 8	302R8	10	--	10	22	5.0	8.5	52	4	2	0.580	1.50	10
	303R8	16	25	12	22	5.8	8.5	52	4	2	0.600	1.95	10
M 10	303R10	16	25	12	25	5.8	10.5	52	4	2	0.600	2.00	10
M 8	304R8	25	35	12	22	6.8	8.5	60	4	2	0.625	2.00	10
	304R10	25	35	12	25	6.8	10.5	60	4	2	0.900	2.10	10
M 10	305R10	35	50	14	26	8.0	10.5	67	5	2	0.800	3.00	10
	305R12	35	50	14	30	8.0	13.0	67	5	2	1.120	3.10	10
M 10	306R10	50	70	16	27	9.8	10.5	72	5	2	0.900	3.60	10
M 12	306R12	50	70	16	30	9.8	13.0	72	5	2	1.120	3.80	10
M 10	307R10	70	95	18	29	11.2	10.5	86	6	3	1.075	5.60	10



Compression cable lugs, Al/Cu with Cu eye

Size of bolt dia.	Part No.	Nominal cross section mm ²		Code	Dimension mm				Number of crimps		Weight 100 St. ~kg Cu	Weight 100 St. ~kg total	Packing unit/pcs
		rm/sm	se		b	d1	d2	l	Cu (5 mm)	Cu (wide)			
M 12	307R12	70	95	18	32	11.2	13.0	86	6	3	1.300	5.70	10
M 10	308R10	95	120	22	32	13.2	10.5	90	6	3	1.435	10.00	5
M 12	308R12	95	120	22	35	13.2	13.0	90	6	3	1.735	9.50	5
M 16	308R16	95	120	22	38	13.2	17.0	90	6	3	2.655	10.00	5
M 12	309R12	120	150	22	35	14.7	13.0	91	6	3	1.810	8.70	5
M 16	309R16	120	150	22	38	14.7	17.0	91	6	3	2.230	8.80	5
M 12	310R12	150	185	25	35	16.3	13.0	103	6	3	2.025	12.20	5
M 16	310R16	150	185	25	41	16.3	17.0	103	6	3	2.655	12.30	5
M 20	310R20	150	185	25	44	16.3	21.0	103	6	3	3.620	12.80	5
M 12	311R12	185	240	28	40	18.3	13.0	106	6	3	2.320	15.00	5
M 16	311R16	185	240	28	42	18.3	17.0	106	6	3	4.975	15.50	5
M 20	311R20	185	240	28	46	18.3	21.0	106	6	3	4.610	15.50	5
M 12	312R12	240	300	32	45	21.0	13.0	116	8	3	2.750	20.00	5
M 16	312R16	240	300	32	45	21.0	17.0	116	8	3	3.400	21.00	5
M 20	312R20	240	300	32	49	21.0	21.0	116	8	3	4.600	22.00	5
M 16	313R16	300	--	34	51	23.3	17.0	124	8	3	3.980	21.60	1
M 20	313R20	300	--	34	51	23.3	21.0	124	8	3	5.510	22.20	1
M 16	314R16	400	--	38	58	26.0	17.0	165	--	4	4.200	35.00	1
M 20	314R20	400	--	38	58	26.0	21.0	165	--	4	5.950	35.00	1



Compression joints, Al/Cu

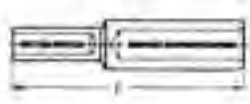

- ▶ For non-tension connections of aluminium conductors to DIN EN 60228 and aluminium cables to DIN EN 50182
- ▶ For Cu round conductors, e.g. to DIN EN 60228 Cl. 1, 2, 5 and 6
- ▶ For non-tension copper cables, to DIN 48201
- ▶ Tube dimensions to DIN 46267, part 1 and 2 and pre-rounded sector shaped conductors
- ▶ Unique tool assignment due to coding

Characteristics

- For connecting non-tension aluminium and copper connections
- Easy to process due to crimp markings
- Simple cable entry due to internal chamfer

Material

- E-aluminium
- Copper (EN13600)

Surface

- Bright

Technical instructions

- Sleeves for compacted conductors and sleeves for 3-core and 4-core cables, see chapter „Sleeves for compacted conductors and sector shaped conductors - Cu“
- Reduction sleeves for connecting unequal cross-sections can be found on page 68
- Tool: see page 115

Additional information

- re = round single solid wire, rm = round multi-stranded, se = sector shaped single solid wire, sm = sector shaped multi-stranded, sector shaped conductors must be pre-rounded

Part No.	Nominal cross section mm ²			Dimension mm			Code		Weight 100 St. ~kg Cu	Weight 100 St. ~kg total	Packing unit/pcs
	rm/sm	Al se	Cu rm/sm	l	Al	Cu	Al	Cu			
322R10	10	16	10	55.0	5.0	4.5	10	6	0.212	1.100	4
322R16	10	16	16	61.0	5.0	5.4	10	8	0.714	1.550	4
323R10	16	25	10	55.0	6.0	4.5	12	6	0.212	1.500	4
323R16	16	25	16	61.0	6.0	5.4	12	8	0.714	1.750	4
324R10	25	35	10	55.0	6.8	4.5	12	6	0.212	1.400	4
324R16	25	35	16	61.0	6.8	5.5	12	8	0.714	1.650	4
324R25	25	35	25	61.0	6.8	7.0	12	10	0.892	1.900	4
324R35	25	35	35	61.0	6.8	8.2	12	12	1.624	2.000	4
324R50	25	35	50	72.0	6.8	10.0	12	14	2.362	3.500	4
324R416	25/4	35	16	61.0	7.6	5.5	12	8	0.714	1.600	4
324R425	25/4	35	25	61.0	7.6	7.0	12	10	0.892	1.850	4
325R16	35	50	16	71.0	8.0	5.5	14	8	0.714	2.500	4
325R25	35	50	25	71.0	8.0	7.0	14	10	0.892	2.650	4
325R35	35	50	35	71.0	8.0	8.2	14	12	1.519	3.300	4
325R50	35	50	50	77.0	8.0	10.0	14	14	2.362	3.530	4
325R616	35/6	50	16	71.0	9.0	5.5	14	8	0.714	2.450	4
325R625	35/6	50	25	71.0	9.0	7.0	14	10	0.892	2.600	4
325R635	35/6	50	35	71.0	9.0	8.2	14	12	1.624	3.250	4
326R16	50	70	16	71.5	9.8	5.5	16	8	0.714	2.850	4
326R25	50	70	25	71.5	9.8	7.0	16	10	0.892	3.200	4
326R35	50	70	35	71.5	9.8	8.2	16	12	1.624	3.800	4
326R50	50	70	50	77.5	9.8	10.0	16	14	2.362	4.550	4
327R16	70	95	16	79.0	11.2	5.5	18	8	0.714	4.100	4



Compression joints, Al/Cu

Part No.	Nominal cross section mm ²			Dimension mm			Code		Weight 100 St. ~kg Cu	Weight 100 St. ~kg total	Packing unit/pcs
	rm/sm	Al se	Cu rm/sm	l	Al	Cu	Al	Cu			
327R25	70	95	25	79.0	11.2	7.0	18	10	0.892	3.950	4
327R35	70	95	35	79.0	11.2	8.2	18	12	1.624	4.900	4
327R50	70	95	50	85.0	11.2	10.0	18	14	2.362	5.700	4
327R70	70	95	70	86.0	11.2	11.5	18	16	2.921	7.250	4
327R95	70	95	95	95.0	11.2	13.5	18	18	4.957	9.360	4
327R120	70	95	120	99.0	11.2	15.5	18	20	5.640	10.540	4
328R16	95	120	16	79.0	13.2	5.5	22	8	0.714	6.150	4
328R25	95	120	25	79.0	13.2	7.0	22	10	0.892	6.300	4
328R35	95	120	35	79.0	13.2	8.2	22	12	1.519	6.800	4
328R50	95	120	50	85.0	13.2	10.0	22	14	2.362	8.050	4
328R70	95	120	70	87.0	13.2	11.5	22	16	3.105	8.200	4
328R95	95	120	95	95.0	13.2	13.5	22	18	4.957	10.350	4
328R120	95	120	120	95.0	13.2	15.5	22	20	5.640	11.550	4
329R35	120	150	35	81.0	14.7	8.2	22	12	1.519	7.600	4
329R50	120	150	50	87.0	14.7	10.0	22	14	2.362	7.900	4
329R70	120	150	70	89.0	14.7	11.5	22	16	3.105	8.500	4
329R95	120	150	95	97.0	14.7	13.5	22	18	4.857	11.000	4
329R120	120	150	120	97.0	14.7	15.5	22	20	5.640	10.280	4
330R16	150	185	16	91.5	16.3	5.4	25	8	0.714	7.800	4
330R25	150	185	25	91.5	16.3	6.8	25	10	0.892	8.000	4
330R35	150	185	35	91.5	16.3	8.2	25	12	1.624	8.400	4
330R50	150	185	50	98.5	16.3	10.0	25	14	2.362	10.200	4
330R70	150	185	70	99.5	16.3	11.5	25	16	3.105	10.350	4
330R95	150	185	95	107.5	16.3	13.5	25	18	4.957	12.650	4
330R120	150	185	120	107.5	16.3	15.5	25	20	5.640	13.900	4
330R150	150	185	150	124.0	16.3	17.0	25	22	8.231	16.700	4
331R50	185	240	50	99.0	18.3	10.0	28	14	2.362	12.100	1
331R70	185	240	70	100.0	18.3	11.5	28	16	3.105	13.000	1
331R95	185	240	95	108.0	18.3	13.5	28	18	4.957	14.450	1
331R120	185	240	120	108.0	18.3	15.5	28	20	5.640	13.720	1
331R150	185	240	150	113.0	18.3	17.0	28	22	8.231	19.550	1
331R185	185	240	185	116.0	18.3	19.0	28	25	9.621	21.000	1
332R50	240	300	50	110.0	21.0	10.0	32	14	2.362	16.500	1
332R70	240	300	70	111.0	21.0	11.5	32	16	3.105	18.000	1
332R95	240	300	95	119.0	21.0	13.5	32	18	4.957	19.000	1
332R120	240	300	120	119.0	21.0	15.5	32	20	5.640	20.500	1
332R150	240	300	150	124.0	21.0	17.0	32	22	8.231	23.300	1
332R185	240	300	185	127.0	21.0	19.0	32	25	9.621	25.500	1
332R240	240	300	240	128.0	21.0	21.5	32	28	12.705	30.100	1
333R120	300	--	120	119.0	23.5	15.5	34	20	5.640	27.800	1
333R150	300	--	150	124.0	23.5	17.0	34	22	8.234	31.100	1
333R185	300	--	185	127.0	23.5	19.0	34	25	9.621	32.700	1
333R240	300	--	240	128.0	23.5	21.5	34	28	12.705	37.500	1
333R300	300	--	300	134.0	23.5	24.5	34	32	16.099	41.700	1



Compression joints with Cu bolts, Al

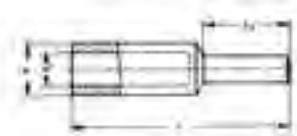
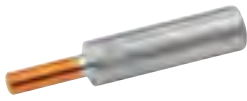

- ▶ For non-tension connections of aluminium conductors to DIN EN 60228 and aluminium cables to DIN EN 50182
- ▶ For pre-rounded sector shaped conductors
- ▶ Tube dimension to DIN 46267, part 2
- ▶ Unique tool assignment due to coding



Characteristics

- For connecting non-tension Al connections in Cu clamps
- Easy to process due to crimp markings
- Simple cable entry due to internal chamfer



Material

- E-aluminium
- Copper (EN13600)



Surface

- Bright



Technical instructions

- Tool: see page 115

Additional information

- re = round single solid wire, rm = round multi-stranded, se = sector shaped single solid wire, sm = sector shaped multi-stranded, sector shaped conductors must be pre-rounded



Part No.	Nominal cross section mm ²		Code	Dimension mm				Bolt mm dia.	Conductor mm dia.	Weight 100 St. ~kg Cu	Weight 100 St. ~kg total	Packing unit/pcs
	rm/sm	se		d Ø	d1	l	l1					
344R	25	35	12	12.0	6.8	58	20	6	6.3	0.462	1.6	10
345R	35	50	14	14.0	8.0	71	22	7	7.5	0.695	2.5	10
346R	50	70	16	16.0	10.0	74	25	8	9.0	1.037	3.3	10
347R	70	95	18	18.5	11.5	87	30	10	10.5	1.958	5.4	10
348R	95	120	22	23.0	13.2	91	33	12	12.5	3.112	8.7	10
349R	120	150	22	23.0	15.0	97	38	12	14.0	3.598	9.0	10
350R	150	185	25	25.5	16.5	108	38	12	15.8	3.598	10.9	10
351R	185	240	28	28.5	18.5	116	44	14	17.5	3.692	15.7	5
352R	240	300	32	32.5	21.5	128	44	16	20.3	7.435	21.8	5
353R	300	--	34	34.5	23.5	131	46	18	22.5	9.410	26.7	1



Cupal washers

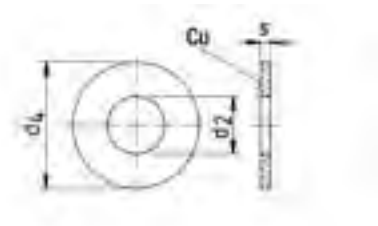

- ▶ Flat washer for processing aluminium and copper cable lugs
- ▶ For connecting copper conductors to aluminium rails

Characteristics

- Processing only in dry environments

Material

- E-Al, one side copper plated

Size of bolt dia.	Part No.	Dimension mm			Weight 100 pcs. ~kg	Packing unit/pcs
		d2	d4	s		
M 6	CS615	6.5	15	2	0.06	10
M 8	CS818	8.5	18	2	0.09	10
M 10	CS1022	11.0	22	2	0.26	10
M 12	CS1228	13.0	28	2	0.44	10
M 14	CS1428	15.0	28	2	0.40	10
M 16	CS1635	17.0	35	2	0.66	10

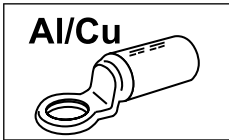

Tool application chart

Compression cable lugs and connectors made from Al/Cu

The tools of the copper side of our Al/Cu compression joints you will find in the tool application chart of copper compression cable lugs and connectors acc. to DIN

Tool type	Crimping range corresponds to nominal cross-section mm ²	Crimping Tool		Catalogue page		Crimp profile
		Part No.	Crimping head / adapter	Crimping Tool	Crimping die	
mechanical, electrical, pneumatic crimping tools with interchangeable die / head	10-70	K354		246	331	⬡
	10-185	K18		248	339	⬡
	10-240	K22		250	344	⬡
Hand hydraulic crimping tools	10-185	HK6018		292	339	⬡
		HK60UNV	+UA18	473	339	⬡
	10-300	HK6022		294	344	⬡
		HK60UNV	+UA22	473	344	⬡
		HK12030		298	350	⬡
		HK12042		300	350	⬡
	150-500	HK120U		302	350	⬡
150-500	HK45		321	358	⬡	
Battery powered crimping tools	10-7	EK354ML		262	331	⬡
		EK354		266	331	⬡
	10-185	EK5018		270	339	⬡
		EK60UNV	+UA18	476	339	⬡
		EKM60UNV	+UA18	475	339	⬡
	10-300	EK6022		274	344	⬡
		EKM6022		272	344	⬡
		EK60UNV	+UA22	476	344	⬡
		EKM60UNV	+UA22	475	344	⬡
		EK12032		280	350	⬡
		EK12042		282	350	⬡
		EK120U		284	350	⬡
		EK135FT	+UA15T	286	350	⬡
	EK120UNV	+UA12T	477	350	⬡	
50-240	EKM60ID		278		⬡	
Hydraulic crimping systems	10-185	THK18		306	339	⬡
	10-300	THK22		308	344	⬡
		HK122EL380		322	350	⬡
	10-500	HK252		320	355	⬡
		HK252EL380		323	355	⬡
Hydraulic crimping heads	10-185	PK18		306	339	⬡
		PK60UNV	+UA18	474	339	⬡
	10-300	PK22		308	344	⬡
		PK60UNV	+UA22	474	344	⬡
		PK12042		312	350	⬡
		PK120U		314	350	⬡
	10-500	PK252		316	355	⬡
	150-500	PK45		318	358	⬡



UNCOMPLICATED - CLAMPS AND SCREW CONNECTORS

Simple connecting of dissimilar materials and cross-sections. Made possible by Klauke clamps and screw connectors: They suit all standard sizes and materials. In compliance with the specified safety measures, compact tab connectors, for instance, can be installed even when live. All very straightforward.



In brief

- ▶ Simple branching without having to cut the main conductor with Klauke H and C clamps
- ▶ H clamps to DIN EN 50164-1 short-circuit current tested
- ▶ Also available in a barrier version for Al/Cu connections



▶ Continuously connected

Save yourself the trouble, the conductor does not need to be cut. Various nominal cross-sections can be clamped with multi-purpose clamps.

- Flexible due to the large cross-sectional range, C-clamps from 2.5 mm² to 185 mm² nominal cross-sections, H-clamps from 70 mm² nominal cross-section
- Efficient connections, without having to cut the main conductor.
- Straightforward connection of various cross-sections.

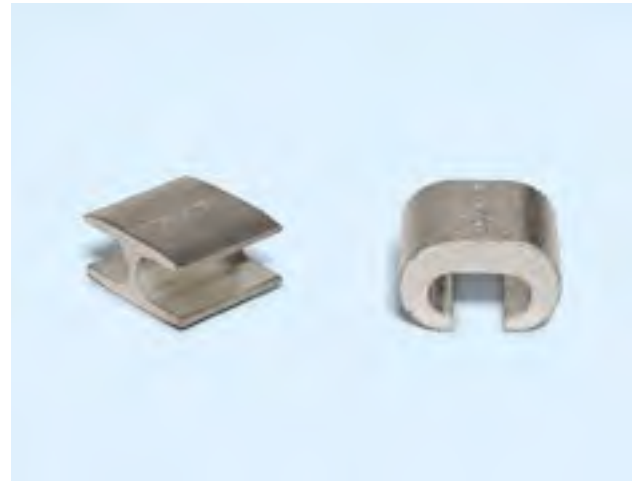

▶ Screwing instead of crimping

Connect the conductors using screws. Why? Because no special tools are needed. Screws are available for every application. To make sure they last, all our screw connectors are produced from high-quality materials. Simply an efficient solution!

- Connections from 2.5 mm² to 185 mm² nominal cross-section
- No special tool required
- The right screw solution to suit a host of requirements
- For aluminium and copper conductors
- For round and sector shaped conductors
- For conductors and wires
- High-quality aluminium alloy

▶ Clamps for continuous supply

We don't abandon your supply. With Klauke clamps, your operation can continue without outage, you carry out the installation even while live. No standstill, the operation continues.

- Especially suitable for the energy supply industry
- Can be installed while live
- Main conductor remains intact
- Different versions available for 3 and 4 core cables



Punched cable lugs, Cu



► For connecting of round conductors to DIN EN 60228 Cl. 1 and 2, for example in lightning protection areas



Characteristics

- Also for outdoor assembly
- Available with 2 or 4 screws



Material

- Copper (ETP)
- Screws: DIN 84 / DIN 933 bronze, F 60

Surface

- Tin-plated to protect against corrosion

Additional information

- Part Number appendix for bright version „BK“

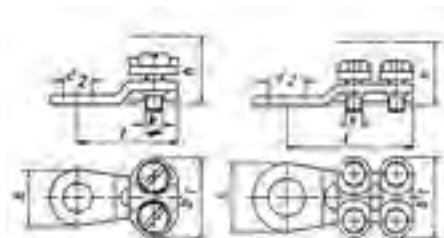

Nominal cross section mm ²	Part No.	Dimension mm						Number of screws	Torque Nm	Weight/pcs. ~kg	Packing unit/pcs
		b	b1	d2	k	h	l				
6 - 10	572R6	15.0	18.0	6.5	M4	10	23.0	2	4	1.30	50
10 - 16	573R6	15.0	20.5	6.5	M5	14	27.0	2	6	1.30	50
	573R8	15.0	20.5	8.5	M5	14	27.0	2	6	1.30	50
16 - 25	574R8	15.0	25.0	8.5	M5	16	30.0	2	6	2.75	50
	584R8	18.5	22.5	8.5	M5	16	36.0	4	6	3.70	25
25 - 35	584R10	19.5	22.5	10.5	M5	16	37.0	4	6	3.75	25
	575R8	18.5	24.0	8.5	M5	16	25.5	2	6	2.50	50
35 - 50	585R8	18.5	24.0	8.5	M5	16	38.5	4	6	4.30	25
	585R10	21.5	24.0	10.5	M5	16	42.0	4	6	4.65	25
50 - 70	585R12	21.5	24.0	13.0	M5	16	42.0	4	6	4.50	25
	586R10	19.0	28.0	10.5	M6	19	46.0	4	8	6.75	25
70 - 95	586R12	21.0	28.0	13.0	M6	19	47.0	4	8	6.70	25
	587R10	23.5	31.0	10.5	M6	19	51.0	4	8	9.35	10
95 - 150	587R12	23.5	31.0	13.0	M6	19	51.0	4	8	9.30	10
	588R10	24.0	34.0	10.5	M6	25	57.0	4	8	12.00	10
150 - 240	588R12	24.0	34.0	13.0	M6	25	57.0	4	8	11.85	10
	589R10	30.0	42.0	10.5	M8	32	61.0	4	20	20.15	10
185 - 300	589R12	30.0	42.0	13.0	M8	32	61.0	4	20	20.20	10
	589R16	30.0	42.0	17.0	M8	32	61.5	4	20	20.10	10
150 - 240	590R10	34.0	48.5	10.5	M8	32	68.5	4	20	24.40	5
	590R12	34.0	48.5	13.0	M8	32	68.5	4	20	24.35	5
150 - 240	590R16	34.0	48.5	17.0	M8	32	68.5	4	20	24.30	5
	590R20	36.0	48.5	21.0	M8	32	70.5	4	20	24.25	5
185 - 300	592R12	32.0	50.0	13.0	M8	37	68.5	4	20	27.95	5
	592R16	32.0	50.0	17.0	M8	37	68.5	4	20	28.00	5
185 - 300	592R20	34.5	50.5	21.0	M8	37	70.0	4	20	27.95	5



Tubular soldering sleeves, CuZn

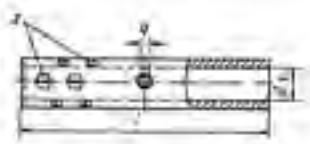

- ▶ For round conductors, e.g. to DIN EN 60228 Cl. 1, 2, 5 and 6
- ▶ Processed without using a crimping tool



Characteristics

- Simple processing due to fixed screws and solder hole



Material

- CuZn 40 Pb 2
- Screws: Steel to DIN 551



Surface

- Tin-plated to protect against corrosion



Technical instructions

- z = number of grub screws
- A connection needs to be soldered

Nominal cross section mm ²	Part No.	Dimension mm				Weight/pcs. ~kg	Packing unit/pcs
		d1	l	Ø q	z		
6	551R	3.5	25	3.3	2	0.60	10
10	552R	4.5	30	3.3	2	1.20	10
16	553R	5.5	40	4.2	4	1.90	10
25	554R	7.0	45	4.2	4	2.85	10
35	555R	8.5	45	5.0	4	3.00	10
50	556R	10.0	48	5.0	4	4.00	10
70	557R	12.0	52	6.8	4	6.30	10
95	558R	13.5	55	6.8	4	8.05	10
120	559R	15.0	60	6.8	4	9.90	10
150	560R	17.0	64	6.8	4	11.80	5
185	561R	19.0	70	6.8	10	14.30	5
240	562R	21.0	70	6.8	10	15.50	5
300	563R	24.0	75	6.8	10	19.30	1

Parallel groove clamps, Cu, 1 screw



- ▶ For non-tension copper cables acc. to DIN 48201 part 1
- ▶ For screwing conductors acc. to DIN EN 60228 Class 1 and 2, for example in lightning protection areas

Characteristics

- Also for outdoor assembly
- Version with 1 screw
- Optionally available with thrust plate for equal pressure distribution

Material

- Copper (ETP)
- Screws: Bronze F 60
- Nut: copper

Surface

- Bright

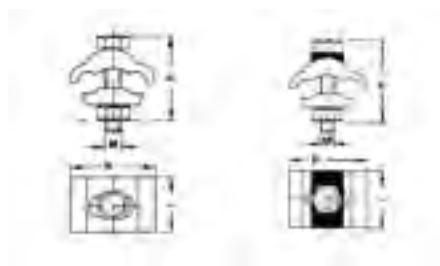

Nominal cross section mm ²	Part No.	Dimension mm			M	Torque Nm	Weight/pcs. ~kg	Packing unit/pcs
		b	h	l				
Without thrust plate								
2.5 - 16	SAK10	19.5	16	16	M5	6	2.10	10
2.5 - 25	SAK12	25.0	21	18	M6	8	4.10	10
	SAK14	25.0	22	20	M7	14	3.95	10
6 - 35	SAK16	28.0	23	20	M7	14	6.0	10
6 - 50	SAK18	32.5	26	24	M7	14	8.0	10
	SAK20	33.5	27	22	M8	20	8.6	10
6 - 70	SAK22	37.5	29	24	M8	20	11.1	5
10 - 95	SAK24	41.0	36	28	M8	20	15.6	5
With thrust plate								
2.5 - 16	SAK11	19.5	16	16	M5	6	2.6	10
2.5 - 25	SAK13	25.0	21	18	M6	8	4.30	10
	SAK15	25.0	22	18	M7	14	4.6	10
6 - 35	SAK17	28.0	23	20	M7	14	6.3	10
6 - 50	SAK19	32.5	26	20	M7	14	7.9	10
	SAK21	33.5	27	22	M8	20	9.1	10
6 - 70	SAK23	37	29	24	M8	20	11.6	5
10 - 95	SAK25	45.0	36	31	M10	39	19.60	5



Parallel groove clamps, Cu, 2 screws



- ▶ For non-tension copper cables acc. to DIN 48201 part 1
- ▶ For screwing conductors acc. to DIN EN 60228 Cl. 1 and 2, for example in lightning protection areas

Characteristics

- Also for outdoor assembly
- Version with 2 screws
- Optionally available with thrust plate for equal pressure distribution

Material

- Copper (ETP)
- Screws: Bronze F 60
- Nut: copper

Surface

- Bright

Technical instructions

- When connecting cross sections 95, 120 and 150 mm² two power branch clamps are to be used due to the current carrying capacity.

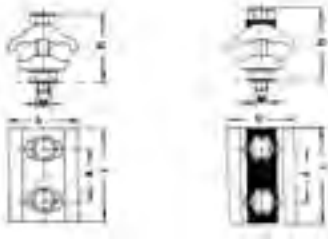

Nominal cross section mm ²	Part No.	Dimension mm			A	M	Torque Nm	Weight/pcs. ~kg	Packing unit/ pcs
		b	h	l					
Without thrust plate									
2.5 - 16	SAK30	20.5	16.0	24	13.0	M5	6	3.7	10
2.5 - 25	SAK32	25.5	21	27	13.5	M6	8	6.4	10
	SAK34	25.0	22	30	15.0	M7	14	7.7	10
6 - 35	SAK36	30.0	23	30	15	M7	14	8.5	10
6 - 50	SAK38	33.0	26	32	16.0	M7	14	12.3	10
10 - 50	SAK40	32.5	27	36	18.0	M8	20	12.9	10
10 - 95	SAK44	45.0	36	46	25.5	M10	39	28.7	5
16 - 150	SAK46	52.5	40	52	26.0	M10	39	37.4	5
With thrust plate									
2.5 - 16	SAK31	19.5	16	24	13.0	M5	6	4.1	10
2.5 - 25	SAK33	25.5	21	27	14.0	M6	8	7.0	10
	SAK35	25.0	22	30	15.0	M7	14	7.9	10
6 - 35	SAK37	28.0	23	32	16.0	M7	14	10.2	10
6 - 50	SAK39	33.0	26	32	17.0	M7	14	12.8	10
10 - 50	SAK41	32.5	27	34.5	18.0	M8	20	14.7	10
6 - 70	SAK43	37.0	29	38.5	19.0	M8	20	19.1	5
10 - 95	SAK45	41.0	36	43	20.0	M8	20	25.0	5
16 - 150	SAK47	52.5	40	52	26.0	M10	39	39.0	5

Branch clamps in C-type, Cu

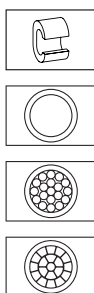

- ▶ Ideal for clamping identical conductor cross-sections e.g. to VDE 60228 Cl. 1 and 2
- ▶ No need to cut the main conductor

Material

- Copper (ETP)

Surface

- Tin-plated to protect against corrosion

Technical instructions

- Optimum conducting characteristics in combination with compound
- Tool: see page 133

Additional information

- Part Number appendix for bright version „BK“
- rm = round multi-stranded; re = round single solid
- * = Also suitable for 25 mm² round solid

Part No.	Hint	Cross section mm ² rm/re		Dimension mm		Weight/pcs. ~kg	Packing unit/pcs
		Main conductor	Tab conductor	b	l		
CK16		16/25	16/25	16.0	15	0.94	25
CK25	*	25/35	25/35	20.0	16	1.68	25
CK35		35/50	35/50	25.7	22	3.42	25
CK50		50/-	50/-	28.0	23	4.88	25
CK70		70/-	70/-	34.0	28	9.69	10
CK95		95/-	95/-	35.0	28	7.30	10

Branch clamps in C-type, Cu, multi-purpose clamps

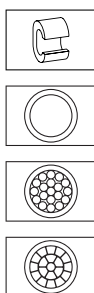

- ▶ Ideal for clamping non-identical conductor cross-sections e.g. to VDE 60228 Cl. 1 and 2
- ▶ No need to cut the main conductor

Material

- Copper (ETP)

Surface

- Tin-plated to protect against corrosion

Technical instructions

- Optimum conducting characteristics in combination with compound
- Tool: see page 133

Additional information

- Part Number appendix for bright version „BK“
- rm = round multi-stranded; re = round single solid

Part No.	Cross section mm ² rm/re		Dimension mm		Weight/pcs. ~kg	Packing unit/pcs
	Main conductor	Tab conductor	b	l		
MCK44	2.5 - 4/2.5 - 4	2.5 - 4/2.5 - 4	9.8	8	0.185	25
MCK1010	6 - 10/10	4 - 6/4 - 10	12.0	12	0.460	25
MCK1016	10 - 16/16	4 - 10/4 - 10	19.0	17	1.900	25
MCK1025	16 - 25/25	4 - 10/4 - 10	19.0	17	1.900	25
MCK3535	16 - 25/25 - 35	16 - 25/16 - 35	20.0	17	1.750	25
MCK2550	35/50	4 - 25/4 - 25	24.8	23	4.400	25
MCK5050	35/50	16 - 35/25 - 50	26.5	23	4.200	25
MCK3570	50 - 70/-	4 - 35/4 - 35	33.8	28	10.700	10

See next page



Branch clamps in C-type, Cu, multi-purpose clamps

Part No.	Cross section mm ² rm/re		Dimension mm		Weight/pcs. ~kg	Packing unit/pcs
	Main conductor	Tab conductor	b	l		
MCK3595	95/-	16 - 35	41.0	30	15.000	10
MCK7095	95/-	35 - 70	41.0	30	14.000	10
MCK120120	120/-	35 - 120	45.0	30	16.550	10
MCK150150	150/-	70 - 150	53.0	35	23.000	5
MCK185185	185/-	95 - 185	60.0	40	33.000	5

Branch clamps in H-type, Cu



- ▶ Ideal for clamping identical conductor cross-sections e.g. to DIN EN 60228
- ▶ Lightning protection tested to EN 50164-1
- ▶ No need to cut the main conductor



Characteristics

- H-shape allows simple processing
- Optimum conducting characteristics when used with compound



Material

- Copper (ETP)



Surface

- Tin-plated to protect against corrosion

Technical instructions

- Tool: see page 134

Additional information

- Part Number appendix for bright version „BK“
- * = To EN 50164-1 lightning current tested

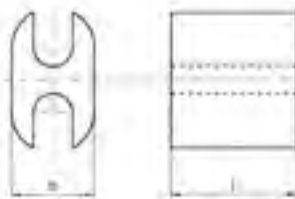

Part No.	Cross section mm ² rm/re		Hint	Dimension mm		Weight/pcs. ~kg	Packing unit/pcs
	Main conductor	Tab conductor		b	l		
AH7070	70	70	*	17.0	28.0	6.5	25
AH9595	95	95		22.0	30.0	10.0	25
AH120120	120	120		24.0	25.0	9.8	25

Compound for branch clamps



- ▶ Optimum conductivity properties for processing aluminium cable lugs and connectors and branch clamps (C and H-type)

Characteristics

- Water-resistant, with corundum for destroying the oxidation layer
- Content/tin: 0.125 kg

Part No.

KF125

Screw connectors for shielded copper wires



- ▶ For connecting different conductor types and materials, e.g. to DIN EN 60228 Class 1 and 2
- ▶ Ideal for connecting identical and different conductor cross-sections

Characteristics

- Special groove profile inside to destroy the oxidation layer when crimping
- With inspection hole for monitoring full cable insertion

Material

- Insulated body: brass (CuZn)
- Screws: stainless steel, tin-plated

Surface

- Tin-plated to protect against corrosion

Technical instructions

- Refer to the installation instructions in the technical appendix on page i-9

Additional information

- rm = round multi-stranded; re = round single solid

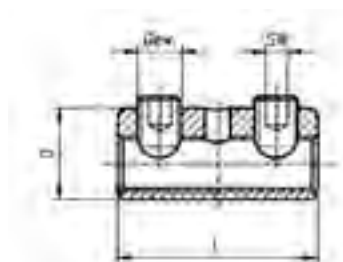

Part No.	Nominal cross section mm ²		Dimension mm				Torque Nm	Weight/pcs. ~kg	Packing unit/ pcs
	re	rm	D	d1	L	AF			
SV100	6 - 35	6 - 25	14	7.2	40	4	10	3.9	4

Screw connectors for street lighting



- ▶ Ideal for connecting various conductor types and materials, e.g. to DIN EN 60228 Cl. 1 and 2
- ▶ Suitable cross-section range for street lighting

Characteristics

- Special groove profile inside to destroy the oxidation layer when crimping
- With inspection hole for monitoring full cable insertion

Material

- Insulated body: brass (CuZn)
- Screws: stainless steel, tin-plated

Surface

- Either bright or tin-plated

Technical instructions

- Refer to the installation instructions in the technical appendix on page i-9

Additional information

- rm = round multi-stranded; re = round single solid

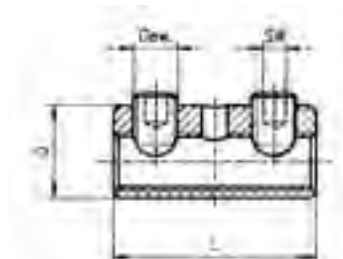

Part No.	Nominal cross section mm ²		Dimension mm				Torque Nm	Weight/pcs. ~kg	Packing unit/ pcs
	re	rm	D	d1	L	AF			
With threaded pin, tin-plated									
SV200	1.5 - 16	1.5 - 16	10	5.5	30	2.5	4	1.35	4
With threaded pin, bright finished									
SV200BK	1.5 - 16	1.5 - 16	10	5.5	30	2.5	4	1.35	4

Screw connector with 2 screws

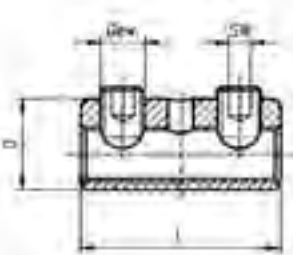

- ▶ For connecting various conductor types and materials, e.g. to DIN EN 60228 Cl. 1 and 2
- ▶ Ideal for connecting identical and different conductor cross-sections
- ▶ Reliable processing due to cable insertion control (dissimilar materials must not come into contact)

Characteristics

- Special groove profile inside to destroy the oxidation layer when crimping
- Either with threaded pin or shear head, shear head partly fixed
- Version with 2 screws

Material

- Insulated body: high-tensile aluminium alloy
- Screws: copper alloy, tin-plated

Surface

- Either bright or tin-plated

Technical instructions

- Refer to the installation instructions in the technical appendix on page-9

Additional information

- * = fixed version, Part Number appendix „NL“
- **= version with fixed countersink shear head, Part Number appendix „VK“
- re = round single solid wire, rm = round multi-stranded, se = sector shaped single solid wire, sm = sector shaped multi-stranded, (r) = pre-rounded, (v) = compacted

Part No.	Nominal cross section mm ²				Hint	Dimension mm			Torque Nm	Weight/ pcs. ~kg	Packing unit/pcs
	re	rm	se	sm		D	L	AF			
With threaded pin, bright finished											
SV303	6 - 35	6 - 25, Cu 2.5 - 50 (v)	--	Cu 2.5 - 35		14	40	4	8	1.5	4
SV300	--	Al 6 - 50 (v)	--	Al 6 - 35, 35 - 70		16.5	40	4	9	1.7	4
SV301	16 - 95	16 - 95	50 - 95, 50 - 120 (120°)	35 - 95 (r)		25	55	5	20	6.6	4
SV308	25 - 150	25 - 150	50 - 150 (90°), 50 - 150 (120°)	--		28	70	6	25	11.3	4
SV302	35 - 50	95 - 185	50 - 185 (90°)	35 - 150		32	80	6	25	16	4
Without threaded pin, bright finished											
SV303V	6 - 35	6 - 25, Cu 2.5 - 50 (v)	--	Cu 2.5 - 35		14	40	4	8	1.5	4
SV300V	--	Al 6 - 50 (v)	--	Al 6 - 35		16.5	40	4	9	1.7	4
SV307V	50 - 70	10 - 70	50 - 70	35 - 70, 35 - 70		22	57	5	15	4.7	4
SV301V	16 - 95	16 - 95	50 - 95, 50 - 150 (120°)	35 - 95 (r)		25	55	5	20	6.6	4
SV302V	35 - 50	35*185	50 - 185 (90°)	35 - 150		32	80	6	25	16	4
With shear head, bright finished											
SV303AK	6 - 35	6 - 25	--	--	*	14	40	4	8	1.5	1
SV303AKNL	6 - 35	6 - 25, Cu 2.5 - 50 (v)	--	Cu 2.5 - 35	*	14	40	4	8	1.5	1
SV304AKNL	--	Al 6 - 50 (v)	--	Al 6 - 35		16.5	40	4	9	1.7	4
SV307AKNL	10 - 70	10 - 70	50 - 70	35 - 70, 35 - 70		22	57	5	15	4.7	4
SV301AK	16 - 95	16 - 95	50 - 95, 50 - 150 (120°)	35 - 95 (r), 35 - 150		25	55	5	20	6.6	4
SV302AK	35 - 50	35 - 185	50 - 185 (90°)	35 - 185 (r)		32	80	6	25	16	4
With shear head, tin - plated											
SV304AKNLV	--	Cu 2.5 - 50 (v), Al 6 - 50 (v)	--	Cu 2.5 - 35, Al 6 - 35		16.5	40	4	9	1.7	4
SV301AKV	16 - 95	16 - 95	50 - 95	35 - 70, 35 - 95 (r)	**	25	55	5	20	6.6	4
SV302AKV	35 - 50	35 - 185	50 - 150 (120°), 50 - 185 (90°)	35 - 150		32	80	6	25	16	4

Screw connector with barrier

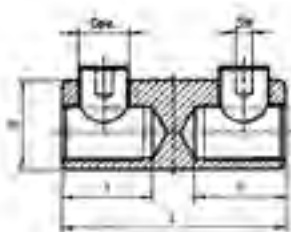

- ▶ For connecting various conductor types and materials, e.g. to DIN EN 60228 Cl. 1 and 2
- ▶ Ideal for connecting identical and different conductor cross-sections

Characteristics

- Special groove profile inside to destroy the oxidation layer when crimping
- Either with threaded pin or shear head, shear head partly fixed
- Version with 2 screws and barrier

Material

- Insulated body: high-tensile aluminium alloy
- Screws: copper alloy, tin-plated

Surface

- Either bright or tin-plated

Technical instructions

- Refer to the installation instructions in the technical appendix on page i-9

Additional information

- re = round single solid wire, rm = round multi-stranded, se = sector shaped single solid wire, sm = sector shaped multi-stranded, (r) = pre-rounded, (v) = compacted

Part No.	Nominal cross section mm ²				Hint	Dimension mm				Torque Nm	Weight/ pcs. ~kg	Packing unit/pcs
	re	rm	se	sm		D	I	L	AF			
With threaded pin, bright finished												
SV315	--	Cu 2.5 - 50 (v), Al 6 - 50 (v)	--	Cu 2.5 - 35, Al 6 - 35		16	17.5	40	4	9	1.7	4
SV309	16 - 95	16 - 95	50 - 95, 50 - 120 (120°)	35 - 70 (r)		25	22	55	5	20	6.6	4
SV320	25 - 150	25 - 150	50 - 150 (90°), 50 - 150 (120°)	35 - 150		28	31	70	6	25	11.3	4
SV310	35 - 50	35 - 185	50 - 185 (90°)	35 - 185 (r)		32	32	80	6	25	16	4
With threaded pin, tin-plated												
SV315V	--	Cu 2.5 - 50 (v), Al 6 - 50 (v)	--	Cu 2.5 - 35, Al 6 - 35		16	17.5	40	4	9	1.7	4
SV309V	16 - 95	16 - 95	50 - 95, 50 - 120 (120°)	35 - 95 (r)		25	22	55	5	20	6.6	4
SV320V	25 - 150	25 - 150	50 - 150 (90°), 50 - 150 (120°)	--		28	31	70	6	25	11.3	4
SV310V	35 - 50	35 - 185	50 - 185 (90°)	35 - 185 (r)		32	32.5	80	6	25	16	4
With shear head, bright finished												
SV311AKNL	6 - 35	6 - 25, Cu 2.5 - 50 (v)	--	Cu 2.5 - 35		14	17.5	40	4	8	1.5	4
SV312AKNL	--	Al 6 - 50 (v)	--	Al 6 - 35, 35 - 70		16	17.5	40	4	9	1.7	4
SV309AK	16 - 95	16 - 95	50 - 95, 50 - 150 (120°)	35 - 95 (r), 35 - 150		25	22	55	5	20	6.6	4
SV310AK	35 - 50	35 - 185	50 - 185 (90°)	35 - 185 (r)		32	32.5	80	6	25	16	4
With shear head, tin-plated												
SV312AKNLV	--	Cu 2.5 - 50 (v), Al 6 - 50 (v)	--	Cu 2.5 - 35, Al 6 - 35		16	17.5	40	4	9	1.7	4
SV319AKNLV	10 - 70	10 - 70	50 - 70	35 - 70		22	24	57	5	15	7.6	4
SV309AKV	16 - 95	16 - 95	50 - 95, 50 - 150 (120°)	35 - 95 (r), 35 - 150	*	25	22	55	5	20	6.6	4
SV310AKV	35 - 50	35 - 185	50 - 185 (90°)	35 - 185 (r)	*	32	32.5	80	6	25	16	4



Screw connector with 4 screws

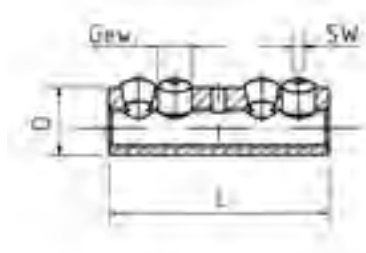

- ▶ For connecting various conductor types and materials, e.g. to DIN EN 60228 Cl. 1 and 2
- ▶ Ideal for connecting identical and different conductor cross-sections
- ▶ Reliable processing due to cable insertion control (dissimilar materials must not come into contact)

Characteristics

- Special groove profile inside to destroy the oxidation layer when crimping
- Available with threaded pin or shear head
- Version with 4 screws

Material

- Insulated body: high-tensile aluminium alloy
- Screws: copper alloy, tin-plated

Surface

- Either bright or tin-plated

Technical instructions

- Refer to the installation instructions in the technical appendix on page i-9

Additional information

- re = round single solid wire, rm = round multi-stranded, se = sector shaped single solid wire, sm = sector shaped multi-stranded

Part No.	Nominal cross section mm ²				Dimension mm			Torque Nm	Weight/pcs. ~kg	Packing unit/pcs
	re	rm	se	sm	D	L	AF			
With threaded pin, bright finished										
SV305	16 - 95	16 - 95	50 - 95	35 - 70, 35 - 70 (r)	25	92	5	20	12	4
SV306	35 - 50	35 - 185	50 - 150 (120°), 50 - 185 (90°)	35 - 185 (r)	32	108	6	25	25	4
With threaded pin, tin-plated										
SV305V	16 - 95	16 - 95	50 - 95	35 - 70, 35 - 70 (r)	25	92	5	20	12	4
SV306V	35 - 50	35 - 185	50 - 150 (120°), 50 - 185 (90°)	35 - 150, 35 - 185 (r)	32	108	6	25	25	4
With shear head, bright finished										
SV305AK	16 - 95	16 - 95	50 - 95	35 - 70, 35 - 70 (r)	25	92	5	20	12	4
SV306AK	35 - 50	35 - 185	50 - 150 (120°), 50 - 185 (90°)	35 - 150, 35 - 185 (r)	32	108	6	25	25	4
With shear head, tin-plated										
SV305AKV	16 - 95	16 - 95	50 - 95	35 - 70, 35 - 70 (r)	25	92	5	20	12	4
SV306AKV	35 - 50	35 - 185	50 - 150 (120°), 50 - 185 (90°)	35 - 150, 35 - 185 (r)	32	108	6	25	25	4



Insulated screw connector

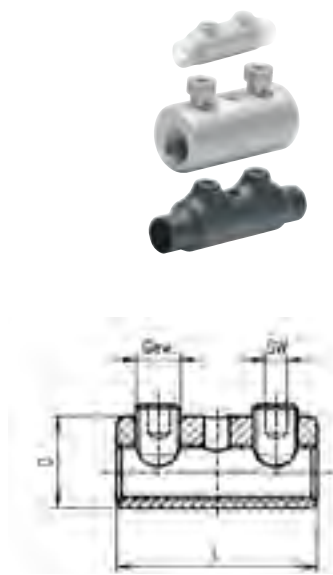

- ▶ For connecting various conductor types and materials, e.g. to DIN EN 60228 Cl. 1 and 2
- ▶ Ideal for connecting identical and different conductor cross-sections
- ▶ Reliable processing due to cable insertion control (dissimilar materials must not come into contact)

Characteristics

- Special groove profile inside to destroy the oxidation layer when crimping
- Insulated body
- Version with 2 screws, without barrier
- Available with threaded pin or shear head

Material

- Insulated body: high-tensile aluminium alloy
- Screws: copper alloy, tin-plated

Surface

- Either bright or tin-plated

Technical instructions

- Refer to the installation instructions in the technical appendix on page i-9

Additional information

- re = round single solid wire, rm = round multi-stranded, se = sector shaped single solid wire, sm = sector shaped multi-stranded

Part No.	Nominal cross section mm ²				Dimension mm			Torque Nm	Weight/pcs. ~kg	Packing unit/pcs
	re	rm	se	sm	D	L	AF			
With threaded pin, bright finished										
SV400	6 - 35	6 - 25	50 - 70 (120°)	35 - 70	14	60	4	8	1.7	4
SV410	16 - 50	16 - 95	50 - 95 (90°), 50 - 150 (120°)	35 - 95 (r), 35 - 150	28.2	58.2	5	20	6	4
SV420	35 - 50	35 - 185	50 - 185 (90°)	35 - 185 (r)	36	84	6	25	14.5	4
With threaded pin, tin-plated										
SV405V	10 - 70	10 - 70	50 - 70, 50 - 150 (120°)	35 - 70, 35 - 150	25	87	5	15	5	4
SV420V	35 - 50	35 - 185	50 - 185 (90°)	35 - 185 (r)	36	84	6	25	14.5	4
With shear head, bright finished										
SV410AK	16 - 50	16 - 95	50 - 70 (120°), 50 - 95 (90°)	35 - 70, 35 - 95 (r)	28.2	58.2	5	20	6	4
SV420AK	35 - 50	35 - 185	50 - 150 (120°), 50 - 185 (90°)	35 - 150, 35 - 185 (r)	36	84	6	25	14.5	4



Screw connector with barrier

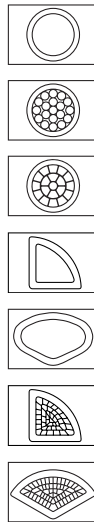
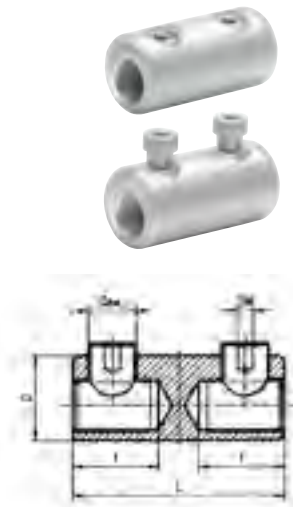

► For connecting various conductor types and materials, e.g. to DIN EN 60228 Cl. 1 and 2

► Ideal for connecting identical and different conductor cross-sections

Characteristics

- Special groove profile inside to destroy the oxidation layer when crimping
- Either with threaded pin or shear head, shear head partly fixed
- Version with 2 screws and barrier

Material

- Insulated body: high-tensile aluminium alloy
- Screws: copper alloy, tin-plated

Surface

- Either bright or tin-plated

Technical instructions

- Refer to the installation instructions in the technical appendix on page i-9

Additional information

- re = round single solid wire, rm = round multi-stranded, se = sector shaped single solid wire, sm = sector shaped multi-stranded, (r) = pre-rounded, (v) = compacted

Part No.	Nominal cross section mm ²				Hint	Dimension mm				Torque Nm	Weight/ pcs. ~kg	Packing unit/pcs
	re	rm	se	sm		D	I	L	AF			
With threaded pin, bright												
SV430	16-50	16-95	50 - 70 (120°), 50 - 95 (90°)	35 - 70, 35 - 95 (r)		28.2	23.6	58.2	5	20	6.6	4
SV440	35-50	35-185	50 - 150 (120°), 50 - 185 (90°)	35 - 150, 35 - 185 (r)		36	34.5	84	6	25	16.0	4
With shear head												
SV430AK	16 - 50	16 - 95	50 - 70 (120°), 50 - 95 (90°)	35 - 70, 35 - 95 (r)		28.2	23.6	58.2	5	20	6.6	4
SV440AK	35 - 50	35 - 185	50 - 150 (120°), 50 - 185 (90°)	35 - 150, 35 - 185 (r)	**	36	34.5	84	6	25	16.0	4

Compact tap connectors with shear heads, three conductor cables



- ▶ Suitable for main and branch conductors made from Al and Cu
- ▶ No need to cut the main conductor
- ▶ For use e.g. with energy suppliers

Characteristics

- VDE: can be installed under voltage with corresponding fully insulated assembly tools
- With shear heads for the main conductor, fixed

Technical instructions

- A mounting instruction is included with every clamp

Additional information

- re = round single solid wire, rm = round multi-stranded, se = sector shaped single solid wire, sm = sector shaped multi-stranded
- Creepage and elongation processes are compensated for by spring washers
- Sequence of contacting can be freely determined

Part No.	Main conductor		Tap conductor		Dimension mm				Torque Nm	Weight/pcs. ~kg	Packing unit/pcs
	se	sm	se	sm	la	lb	Width	AF			
KSK1503	70 - 150	150	95 (r)	6 - 70 (r)	84	76	45	5	20	0.35	1

Compact tap connectors with shear heads, four conductor cables



- ▶ Suitable for main and branch conductors made from Al and Cu
- ▶ No need to cut the main conductor
- ▶ For use e.g. with energy suppliers

Characteristics

- VDE: can be installed under voltage with corresponding fully insulated assembly tools
- With shear heads for the main conductor, fixed

Technical instructions

- A mounting instruction is included with every clamp

Additional information

- re = round single solid wire, rm = round multi-stranded, se = sector shaped single solid wire, sm = sector shaped multi-stranded
- Creepage and elongation processes are compensated for by spring washers
- Sequence of contacting can be freely determined

Part No.	Main conductor		Tap conductor		Dimension mm				Torque Nm	Weight/pcs. ~kg	Packing unit/pcs
	se	sm	se	sm	la	lb	Width	AF			
KSK1504	70 - 150	150	95 (r)	6 - 70 (r)	107	90	46	5	20	0.63	1
KSK1854	70 - 150	150	95 (r)	6 - 70 (r)	107	90	46	5	20	0.58	1



Compact tap connectors, four conductor cables, for main conductor 25 - 50 mm²



- ▶ Suitable for main and branch conductors made from Al and Cu
- ▶ No need to cut the main conductor
- ▶ For use e.g. with energy suppliers

Characteristics

- VDE: can be installed under voltage with corresponding fully insulated assembly tools

Technical instructions

- A mounting instruction is included with every clamp

Additional information

- re = round single solid wire, rm = round multi-stranded, se = sector shaped single solid wire, sm = sector shaped multi-stranded
- Creepage and elongation processes are compensated for by spring washers
- Sequence of contacting can be freely determined

Part No.	Main conductor			Tap conductor			Dimension mm				Torque Nm	Weight/ pcs. ~kg	Packing unit/pcs
	se	sm	rm	se	sm	rm	la	lb	Width	AF			
KSK504	Cu 25 - 50, Al 35 - 50	Cu 25 - 50	Cu 25 - 50	50	6-35		88	75	50	5	15	0.46	1

Compact tap connectors, four conductor cables, for main conductor 70 - 185 mm²



- ▶ Suitable for main and branch conductors made from Al and Cu
- ▶ No need to cut the main conductor
- ▶ For use e.g. with energy suppliers

Characteristics

- VDE: can be installed under voltage with corresponding fully insulated assembly tools
- With threaded pins for the main conductor

Technical instructions

- A mounting instruction is included with every clamp

Additional information

- re = round single solid wire, rm = round multi-stranded, se = sector shaped single solid wire, sm = sector shaped multi-stranded
- Creepage and elongation processes are compensated for by spring washers
- Sequence of contacting can be freely determined

Part No.	Main conductor			Tap conductor			Dimension mm				Torque Nm	Weight/ pcs. ~kg	Packing unit/pcs
	se	sm	re	se	sm	rm	la	lb	Width	AF			
SKR1204	120	70 - 95		50 (r)	6 - 35 (r)		90	77	50	5	20	0.46	1
SKR150504	150	70 - 150	50	50	6 - 35		93	80	50	5	20	0.46	1
SKR1504	70 - 150	150		95 (r)	6 - 70 (r)		107	90	46	5	20	0.62	1
SKR1501504	95 - 150	150		150	16 - 120	16 - 120	118	118	93	5	20	1.34	1
SKR1854	185	95 - 150		95 (r)	6 - 70		107	96	46	5	20	0.58	1



Compact tap connectors, three conductor cables



- ▶ Suitable for main and branch conductors made from Al and Cu
- ▶ No need to cut the main conductor
- ▶ For use e.g. with energy suppliers

Characteristics

- VDE: can be installed under voltage with corresponding fully insulated assembly tools
- With threaded pins for the main conductor

Technical instructions

- A mounting instruction is included with every clamp

Additional information

- re = round single solid wire, rm = round multi-stranded, se = sector shaped single solid wire, sm = sector shaped multi-stranded

Part No.	Main conductor				Tap conductor		Dimension mm					Thread DIN 13	Weight/ pcs. ~kg	Packing unit/pcs
	se	sm	rm	re	se	sm	la	lb	Width	Bolts Circle dia.	AF			
SKR1503	70 - 150	70 - 150	70 - 150	70 - 150	6 - 70	6 - 95	84	76	45	90	5	M10x1/ M10	0.38	1

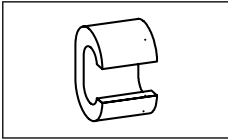

Tool application chart

C-Clamps

Tool type	Crimping range corresponds to nominal cross-section mm ²	Crimping Tool		Catalogue page			Crimp profile
		Part No.	Crimping head / adapter	Crimping Tool	Crimping die		
Mechanical, electrical, pneumatic crimping tools with interchangeable die / head	4-35	K354		246	331	331	○
	4-50	K18		248	339	339	○
		K22		250	345	345	○
Hand hydraulic crimping tools	4-50	HK6018		292	339	339	○
		HK60UNV	+UA18	473	339	339	○
		HK6022		294	345	345	○
		HK60UNV	+UA22	473	345	345	○
	10-70	HK12030		298	351	351	○
		HK12042		300	351	351	○
		HK120U		302	351	351	○
Battery powered crimping tools	4-35	EK354ML		262	331	331	○
		EK354		266	331	331	○
	4-50	EK5018		270	339	339	○
		EK60UNV	+UA18	476	339	339	○
		EKM60UNV	+UA18	475	339	339	○
		EK6022		274	345	345	○
		EKM6022		272	345	345	○
		EK60UNV	+UA22	476	345	345	○
		EKM60UNV	+UA22	475	345	345	○
	10-70	EK12032		280	351	351	○
		EK12042		282	351	351	○
		EK120U		284	351	351	○
		EK135FT	+UA15T	286	351	351	○
		EK120UNV	+UA12T	477	351	351	○
	Hydraulic crimping systems	4-50	THK18		306	339	339
THK22				308	345	345	○
10-70		HK122EL380		322	351	351	○
10-185		HK252		320	356	356	○
	HK252EL380		323	356	356	○	
Hydraulic crimping heads	4-50	PK18		306	339	339	○
		PK60UNV	+UA18	474	339	339	○
		PK22		308	345	345	○
		PK60UNV	+UA22	474	345	345	○
	10-70	PK12042		312	351	351	○
		PK120U		314	351	351	○
	10-185	PK252		316	356	356	○

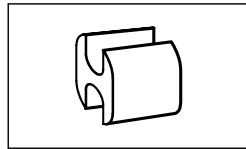

Tool application chart

H-Clamps

Tool type	Crimping range corresponds to nominal cross-section mm ²	Crimping Tool		Catalogue page		Crimp profile
		Part No.	Crimping head / adapter	Crimping Tool	Crimping die	
Mechanical, electrical, pneumatic crimping tools with interchangeable die / head	70	K22		250	345	○
Hand hydraulic crimping tools	70	HK6022		294	345	○
	70-120	HK12030		298	351	○
		HK12042		300	351	○
		HK120U		302	351	○
Battery powered crimping tools	70	EK6022		274	345	○
		EKM6022		272	345	○
		EK60UNV	+UA22	476	345	○
	70-120	EK12032		280	351	○
		EK12042		282	351	○
		EK120U		284	351	○
		EK135FT	+UA15T	286	351	○
		EK120UNV	+UA12T	477	351	○
Hydraulic crimping systems	70	THK22		308	345	○
	70-120	HK122EL380		322	351	○
		HK252		320	356	○
		HK252EL380		323	356	○
Hydraulic crimping heads	70	PK22		308	345	○
	70-120	PK12042		312	351	○
		PK120U		314	351	○
		PK252		316	356	○





PROTECTION - CABLE END-SLEEVES, INSULATED AND NON-INSULATED

Klauke joins together what belongs together. Cable end-sleeves prevent the conductors splicing before they are connected in clamps. All wires remain together. Easy-Entry insulation speeds up the insertion of wires into the sleeve. Fine-stranded conductors in particular benefit from a special trapezoidal crimp. No splicing, no time wasted. Your conductors are protected and can be cleanly processed

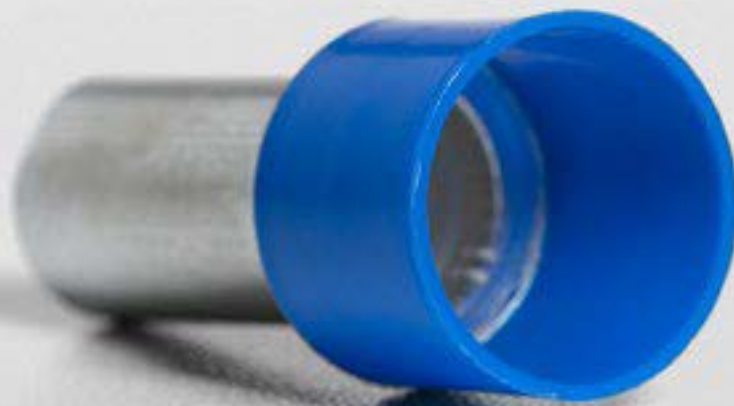

In brief

- ▶ Stops conductors splicing
- ▶ Improved contact
- ▶ No risk of short-circuit due to bent strands
- ▶ Produced from high-quality copper
- ▶ Surface treatment with tin or in special versions with silver



▶ **Simple diversity**

We have to admit: Cable end-sleeves are a simple product. Due to the differing crimp shapes in the range and the high-quality materials used in production, the sleeves are just incredibly good.

- Broad range: To DIN standards, for short circuit-resistant conductors, in various lengths, with and without insulating collars

- Marked to DIN colour code
- Twin cable end-sleeves for connecting in confined areas
- High-quality material for optimum conducting properties
- CSA-approved

▶ **Always the right crimp shape**

We give every cable end-sleeve its perfect crimp shape. No matter where the conductor is to be laid later, we have a solution for you.

- The correct crimp shape for every connecting terminal
- Crimp shapes matched to the DIN dimensions
- For compacted conductors
- Connect without risk of short-circuit



The easy-entry insulation enables fast insertion of conductors with no splicing.

▶ **Easy-Entry insulation**

The special Easy-Entry insulation makes it easier to insert the conductor into the sleeves. In addition, the insulation is highly-resistant, to temperatures of up to 105 °C for example.

- Easy-Entry insulation for convenient insertion of the conductor
- Temperature-resistant to 105 °C
- No toxic vapours in case of fire
- Ageing-resistant plastic collars



Cable end-sleeves to DIN, Cu



- ▶ For fine and superfine stranded conductors, e.g. to DIN EN 60228 Cl. 5 and 6
- ▶ Optimal cable entry due to widened sleeve



Characteristics

- To DIN 46228, part 1 and similar



Material

- Copper (EN13600)

Surface

- Tin-plated to protect against corrosion

Technical instructions

- Tool: see page 150

Additional information

- Silvered version also available, without Part Number appendix "V", exception: Part Number 705V in silvered version = Part No. 7050
- * = not standardised

Nominal cross section mm ²	Part No.	Hint	Dimension mm				Weight/1000 pcs. ~ kg	Packing unit/pcs
			d1	d2	l	s		
0.25	695V	*	0.75	1.7	5	0.15	0.02	1000
	697V	*	0.75	1.7	7	0.15	0.03	1000
0.34	705V	*	0.85	1.8	5	0.15	0.02	1000
	707V	*	0.85	1.8	7	0.15	0.03	1000
0.5	71S6V		1.00	2.1	6	0.15	0.03	1000
	71S8V	*	1.00	2.1	8	0.15	0.04	1000
	71S10V		1.00	2.1	10	0.15	0.05	1000
0.75	716V		1.20	2.3	6	0.15	0.04	1000
	718V	*	1.20	2.3	8	0.15	0.05	1000
	7110V		1.20	2.3	10	0.15	0.06	1000
	7112V	*	1.20	2.3	12	0.15	0.08	1000
	7115V	*	1.20	2.3	15	0.15	0.09	1000
1	72S6V		1.40	2.5	6	0.15	0.04	1000
	72S8V	*	1.40	2.5	8	0.15	0.06	1000
	72S10V		1.40	2.5	10	0.15	0.07	1000
	72S12V	*	1.40	2.5	12	0.15	0.08	1000
	72S15V	*	1.40	2.5	15	0.15	0.10	1000
1.5	726V	*	1.70	2.8	6	0.15	0.05	1000
	727V		1.70	2.8	7	0.15	0.06	1000
	728V	*	1.70	2.8	8	0.15	0.07	1000
	7210V		1.70	2.8	10	0.15	0.09	1000
	7212V		1.70	2.8	12	0.15	0.10	1000
	7215V	*	1.70	2.8	15	0.15	0.13	1000
	7218V		1.70	2.8	18	0.15	0.15	1000
	7220V	*	1.70	2.8	20	0.15	0.17	1000
2.5	737V		2.20	3.4	7	0.15	0.08	1000
	738V	*	2.20	3.4	8	0.15	0.09	1000
	7310V		2.20	3.4	10	0.15	0.11	1000
	7312V		2.20	3.4	12	0.15	0.13	1000
	7315V	*	2.20	3.4	15	0.15	0.17	1000
	7318V		2.20	3.4	18	0.15	0.20	1000
	7320V	*	2.20	3.4	20	0.15	0.22	1000

Cable end-sleeves nach DIN, Cu

Nominal cross section mm ²	Part No.	Hint	Dimension mm				Weight/ 1000 pcs. ~ kg	Packing unit/pcs
			d1	d2	l	s		
4	748V	*	2.80	4.0	8	0.20	0.14	1000
	749V		2.80	4.0	9	0.20	0.16	1000
	7410V	*	2.80	4.0	10	0.20	0.17	1000
	7412V		2.80	4.0	12	0.20	0.20	1000
	7415V		2.80	4.0	15	0.20	0.27	1000
	7418V		2.80	4.0	18	0.20	0.32	1000
	7420V	*	2.80	4.0	20	0.20	0.35	1000
6	7510V		3.50	4.7	10	0.20	0.23	100
	7512V		3.50	4.7	12	0.20	0.27	100
	7515V		3.50	4.7	15	0.20	0.34	100
	7518V		3.50	4.7	18	0.20	0.40	100
	7520V	*	3.50	4.7	20	0.20	0.45	100
	7525V	*	3.50	4.7	25	0.20	0.56	100
10	7610V	*	4.5	5.8	10	0.2	0.27	100
	7612V		4.5	5.8	12	0.2	0.33	100
	7615V		4.5	5.8	15	0.2	0.41	100
	7618V		4.5	5.8	18	0.2	0.49	100
	7620V	*	4.5	5.8	20	0.2	0.55	100
	7625V	*	4.5	5.8	25	0.2	0.68	100
16	7712V		5.8	7.5	12	0.2	0.43	100
	7715V		5.8	7.5	15	0.2	0.53	100
	7718V		5.8	7.5	18	0.2	0.60	100
	7720V	*	5.8	7.5	20	0.2	0.70	100
	7725V		5.8	7.5	25	0.2	0.87	100
	7732V		5.8	7.5	32	0.2	1.11	100
25	7812V	*	7.3	9.5	12	0.2	0.80	50
	7815V		7.3	9.5	15	0.2	0.99	50
	7818V		7.3	9.5	18	0.2	1.18	50
	7820V	*	7.3	9.5	20	0.2	1.31	50
	7825V		7.3	9.5	25	0.2	1.63	50
	7828V	*	7.3	9.5	28	0.2	1.82	50
35	7832V		7.3	9.5	32	0.2	2.07	50
	7912V	*	8.3	11.0	12	0.2	0.90	50
	7915V	*	8.3	11.0	15	0.2	1.12	50
	7918V		8.3	11.0	18	0.2	1.34	50
	7920V	*	8.3	11.0	20	0.2	1.48	50
	7922V	*	8.3	11.0	22	0.2	1.63	50
	7925V		8.3	11.0	25	0.2	1.80	50
50	7930V	*	8.3	11.0	30	0.2	2.20	50
	7932V		8.3	11.0	32	0.2	2.35	50
	8018V		10.5	13.0	18	0.3	1.69	50
	8022V	*	10.5	13.0	22	0.3	2.05	50
	8025V		10.5	13.0	25	0.3	2.32	50
	8030V	*	10.5	13.0	30	0.3	2.77	50
	8032V		10.5	13.0	32	0.3	2.95	50

See next page

Cable end-sleeves nach DIN, Cu

Nominal cross section mm ²	Part No.	Hint	Dimension mm				Weight/1000 pcs. ~ kg	Packing unit/pcs
			d1	d2	l	s		
70	8122V	*	12.7	15.0	22	0.4	3.31	25
	8125V	*	12.7	15.0	25	0.4	3.75	25
	8130V	*	12.7	15.0	30	0.4	4.48	25
	8132V	*	12.7	15.0	32	0.4	4.78	25
95	8225V	*	14.7	17.0	25	0.4	4.32	25
	8230V	*	14.7	17.0	30	0.4	5.17	25
	8232V	*	14.7	17.0	32	0.4	5.17	25
	8234V	*	14.7	17.0	34	0.4	5.84	25
120	8330V	*	16.7	19.0	30	0.5	7.35	25
	8332V	*	16.7	19.0	32	0.5	7.83	25
	8334V	*	16.7	19.0	34	0.5	8.31	25
	8338V	*	16.7	19.0	38	0.5	9.28	25
150	8340V	*	16.7	19.0	40	0.5	9.76	25
	8432V	*	18.7	21.0	32	0.5	8.75	25
	8434V	*	18.7	21.0	34	0.5	9.28	25
	8438V	*	18.7	21.0	38	0.5	10.36	25
185	8440V	*	18.7	21.0	40	0.5	10.89	25
	8532V	*	20.2	23.5	32	0.6	11.38	25
	8540V	*	20.2	23.5	40	0.6	14.17	25
	8634V	*	23.0	24.0	34	0.5	11.25	25
240	8640V	*	23.0	24.0	40	0.5	13.23	25

Cable end-sleeves to DIN, CuZn



► For fine and superfine stranded conductors, e.g. to DIN EN 60228 Cl. 5 and 6



Characteristics

- To DIN 46228, part 2



Material

- Brass (CuZn)

Surface

- Tin-plated to protect against corrosion

Technical instructions

- Tool: see page 152

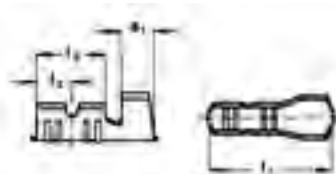

Nominal cross section mm ²	Nominal size to DIN	Part No.	Dimension mm					Weight/1000 pcs. ~ kg	Packing unit/pcs
			a1	l1	l2	l3	s		
0.5-1	B 1 - 7	SH271	2.5	11	3.5	7	0.3	0.20	100
1.5	B 1.5 - 7	SH272	2.5	11	3.5	7	0.3	0.23	100
2.5	B 2.5 - 7	SH273	2.5	11	3.5	7	0.3	0.32	100

Insulated cable end-sleeves to DIN, with Easy-Entry



- ▶ For fine and superfine stranded conductors, e.g. to DIN EN 60228 Cl. 5 and 6
- ▶ Easy-Entry insulation for splice-free cable insertion



Characteristics

- Colour-coding and tube dimension to DIN 46228, part 4
- Halogen-free
- Heat resistant to 105° C



Material

- Copper (EN13600)
- Synthetic material: polypropylene



Surface

- Tin-plated to protect against corrosion

Technical instructions

- Tool: see page 150

Additional information

- * = not standardised
- *** = quantities in one bag

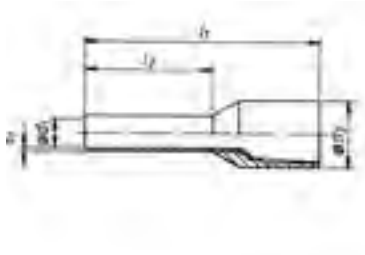

Nominal cross section mm ²	Part No.	Colour	Hint	Dimension mm					Weight/ 1000 pcs. ~ kg	Packing unit/ pcs
				d1	d3	l1	l2	s1		
0.5	4696	□		1.0	3.1	12	6	0.15	0.070	1000
	4698	□		1.0	3.1	14	8	0.15	0.070	1000
	GR4698	□	***	1.0	3.1	14	8	0.15	0.070	500
	46910	□		1.0	3.1	16	10	0.15	0.085	1000
0.75	4706	■		1.2	3.3	12	6	0.15	0.080	1000
	4708	■		1.2	3.3	14	8	0.15	0.080	1000
	GR4708	■	***	1.2	3.3	14	8	0.15	0.080	500
	47010	■		1.2	3.3	16	10	0.15	0.100	1000
1	47012	■		1.2	3.3	18	12	0.15	0.105	1000
	4716	■		1.4	3.5	12	6	0.15	0.090	1000
	4718	■		1.4	3.5	14	8	0.15	0.100	1000
	GR4718	■	***	1.4	3.5	14	8	0.15	0.100	500
1.5	47110	■		1.4	3.5	16	10	0.15	0.120	1000
	47112	■		1.4	3.5	18	12	0.15	0.125	1000
	4726	■		1.7	4.0	12	6	0.15	0.105	1000
	4728	■		1.7	4.0	14	8	0.15	0.110	1000
	GR4728	■	***	1.7	4.0	14	8	0.15	0.110	500
	47210	■		1.7	4.0	16	10	0.15	0.130	1000
2.5	47212	■		1.7	4.0	18	12	0.15	0.150	1000
	47218	■		1.7	4.0	24	18	0.15	0.190	1000
	4738	■		2.2	4.7	14	8	0.15	0.150	1000
	GR4738	■	***	2.2	4.7	14	8	0.15	0.150	500
4	47312	■		2.2	4.7	18	12	0.15	0.200	1000
	47318	■		2.2	4.7	24	18	0.15	0.250	1000
	47410	■		2.8	5.4	17	10	0.20	0.210	100
	47412	■		2.8	5.4	20	12	0.20	0.250	100
6	47418	■		2.8	5.4	26	18	0.20	0.320	100
	47512	■		3.5	6.9	20	12	0.20	0.350	100
	47518	■		3.5	6.9	26	18	0.20	0.460	100
10	47612	■		4.5	8.4	22	12	0.20	0.450	100
	47618	■		4.5	8.4	28	18	0.20	0.650	100

See next page

Insulated cable end-sleeves to DIN, with Easy-Entry

Nominal cross section mm ²	Part No.	Colour	Hint	Dimension mm					Weight/ 1000 pcs. ~ kg	Packing unit/ pcs
				d1	d3	l1	l2	s1		
16	47712	■		5.8	9.6	24	12	0.20	0.650	100
	47718	■		5.8	9.6	28	18	0.20	0.800	100
25	47816	■		7.3	12.0	30	16	0.20	1.600	50
	47818	■		7.3	12.0	30	18	0.20	1.700	50
	47822	■		7.3	12.0	36	22	0.20	2.000	50
35	47916	■		8.3	13.5	30	16	0.20	1.900	50
	47918	■		8.3	13.5	30	18	0.20	2.100	50
	47925	■		8.3	13.5	39	25	0.20	2.500	50
50	48020	■		10.3	16.0	36	20	0.30	3.300	50
	48025	■		10.3	16.0	40	25	0.30	3.600	50
70	48121	■	*	13.5	17.2	37	21	0.40	4.620	25
95	48225	■	*	14.5	19.2	44	25	0.40	6.000	25
120	48327	■	*	16.7	21.4	48	27	0.45	7.850	25
150	48432	■	*	19.5	25.0	58	32	0.50	12.330	25

Insulated cable end-sleeves to DIN with Easy-Entry, colour code 1



- ▶ For fine and superfine stranded conductors, e.g. to DIN EN 60228 Cl. 5 and 6
- ▶ Easy-Entry insulation for splice-free cable insertion



Characteristics

- To DIN 46228, part 4, (0.5 - 50 mm²)
- Halogen-free
- Heat resistant to 105° C



Material

- Copper (EN13600)
- Synthetic material: polypropylene



Surface

- Tin-plated to protect against corrosion

Technical instructions

- Tool: see page 150

Additional information

- * = not standardised
- ** = quantities in one bag

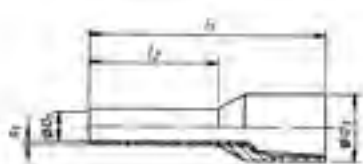

Nominal cross section mm ²	Part No.	Colour	Hint	Dimension mm					Weight/ 1000 pcs. ~ kg	Packing unit/ pcs
				d1	d3	l1	l2	s1		
0.14	166GR	■	*	0.7	2.1	10.0	6	0.15	0.035	1000
	166GRL	■	*	0.7	2.1	12.0	8	0.15	0.040	1000
0.25	167H	■	*	0.8	2.3	10.0	6	0.15	0.045	1000
	167HL	■	*	0.8	2.3	12.0	8	0.15	0.050	1000
0.34	168T	■	*	0.8	2.5	10.0	6	0.15	0.045	1000
	168TL	■	*	0.8	2.5	12.0	8	0.15	0.050	1000
0.5	1690K	■		1.0	3.1	12.0	6	0.15	0.070	1000
	1690	■		1.0	3.1	14.0	8	0.15	0.070	1000
	GR1690	■	**	1.0	3.1	14.0	8	0.15	0.070	500
	1690H	■		1.0	3.1	16.0	10	0.15	0.085	1000

See next page



Insulated cable end-sleeves to DIN with Easy-Entry, colour code 1

Nominal cross section mm ²	Part No.	Colour	Hint	Dimension mm					Weight/ 1000 pcs. ~ kg	Packing unit/ pcs
				d1	d3	l1	l2	s1		
0.75	170WK			1.2	3.3	12.0	6	0.15	0.080	1000
	170W			1.2	3.3	14.0	8	0.15	0.080	1000
	GR170W		**	1.2	3.3	14.0	8	0.15	0.080	500
	170WH			1.2	3.3	16.0	10	0.15	0.100	1000
	170WL			1.2	3.3	18.0	12	0.15	0.105	1000
1	171GK			1.4	3.5	12.0	6	0.15	0.090	1000
	171G			1.4	3.5	14.0	8	0.15	0.100	1000
	GR171G		**	1.4	3.5	14.0	8	0.15	0.100	500
	171GH			1.4	3.5	16.0	10	0.15	0.120	1000
	171GL			1.4	3.5	18.0	12	0.15	0.125	1000
1.5	172RK			1.7	4.0	12.0	6	0.15	0.105	1000
	172RO			1.7	4.0	14.0	8	0.15	0.110	1000
	GR172RO		**	1.7	4.0	14.0	8	0.15	0.110	500
	172RH			1.7	4.0	16.0	10	0.15	0.130	1000
	172RM			1.7	4.0	18.0	12	0.15	0.140	1000
2.5	172RL			1.7	4.0	24.0	18	0.15	0.190	1000
	173B			2.2	4.7	14.0	8	0.15	0.150	1000
	GR173B		**	2.2	4.7	14.0	8	0.15	0.150	500
	173BH			2.2	4.7	18.0	12	0.15	0.200	1000
	173BL			2.2	4.7	24.0	18	0.15	0.250	1000
4	174GR			2.8	5.4	17.0	10	0.20	0.210	100
	174GRH			2.8	5.4	20.0	12	0.20	0.250	100
	174GRL			2.8	5.4	26.0	18	0.20	0.320	100
6	175S			3.5	6.9	20.0	12	0.20	0.350	100
	175SL			3.5	6.9	26.0	18	0.20	0.460	100
10	176E			4.5	8.4	22.0	12	0.20	0.450	100
	176EL			4.5	8.4	28.0	18	0.20	0.650	100
16	177GR			5.8	9.6	24.0	12	0.20	0.650	100
	177GRL			5.8	9.6	28.0	18	0.20	0.800	100
25	178BR			7.3	12.0	30.0	16	0.20	1.600	50
	178BRL			7.3	12.0	36.0	22	0.20	2.000	50
35	179B			8.3	13.5	30.0	16	0.20	1.900	50
	179BL			8.3	13.5	39.0	25	0.20	2.500	50
50	1800			10.3	16.0	36.0	20	0.30	3.300	50
	1800L			10.3	16.0	40.0	25	0.30	4.000	50

Insulated cable end-sleeves to DIN with Easy-Entry, colour code 2



- ▶ For fine and superfine stranded conductors, e.g. to DIN EN 60228 Cl. 5 and 6
- ▶ Easy-Entry insulation for splice-free cable insertion



Characteristics

- To DIN 46228, part 4, (0.5 - 25 mm²)
- Halogen-free
- Heat resistant to 105° C



Material

- Copper (EN13600)
- Synthetic material: polypropylene



Surface

- Tin-plated to protect against corrosion

Technical instructions

- Tool: see page 150

Additional information

- * = not standardised
- ** = quantities in one bag

Nominal cross section mm ²	Part No.	Colour	Hint	Dimension mm					Weight/ 1000 pcs. ~ kg	Packing unit/ pcs
				d1	d3	l1	l2	s1		
0.14	1666	■	*	0.7	2.1	10.0	6	0.15	0.035	1000
	1668	■	*	0.7	2.1	12.0	8	0.15	0.040	1000
0.25	1676	■	*	0.8	2.3	10.0	6	0.15	0.045	1000
	1678	■	*	0.8	2.3	12.0	8	0.15	0.050	1000
0.34	1686	■	*	0.8	2.5	10.0	6	0.15	0.045	1000
	1688	■	*	0.8	2.5	12.0	8	0.15	0.050	1000
0.5	1696	■		1.0	3.1	12.0	6	0.15	0.070	1000
	1698	■		1.0	3.1	14.0	8	0.15	0.080	1000
	GR1698	■	**	1.0	3.1	14.0	8	0.15	0.080	500
0.75	1706	■		1.2	3.3	12.0	6	0.15	0.080	1000
	1708	■		1.2	3.3	14.0	8	0.15	0.095	1000
	GR1708	■	**	1.2	3.3	14.0	8	0.15	0.095	500
1	1716	■		1.4	3.5	12.0	6	0.15	0.085	1000
	1718	■		1.4	3.5	14.0	8	0.15	0.100	1000
	GR1718	■	**	1.4	3.5	14.0	8	0.15	0.100	500
	1726	■		1.7	4.0	12.0	6	0.15	0.100	1000
1.5	1728	■		1.7	4.0	14.0	8	0.15	0.120	1000
	GR1728	■	**	1.7	4.0	14.0	8	0.15	0.120	500
	17210	■		1.7	4.0	16.0	10	0.15	0.130	1000
	17212	■		1.7	4.0	18.0	12	0.15	0.140	1000
	17218	■		1.7	4.0	24.0	18	0.15	0.220	1000
2.5	1738	■		2.2	4.7	14.0	8	0.15	0.140	1000
	GR1738	■	**	2.2	4.7	14.0	8	0.15	0.140	500
	17312	■		2.2	4.7	18.0	12	0.15	0.200	1000
	17318	■		2.2	4.7	24.0	18	0.15	0.280	1000
4	17410	■		2.8	5.4	17.0	10	0.20	0.260	100
	17412	■		2.8	5.4	20.0	12	0.20	0.300	100
	17418	■		2.8	5.4	26.0	18	0.20	0.390	100
6	17512	■		3.5	6.9	20.0	12	0.20	0.410	100
	17518	■		3.5	6.9	26.0	18	0.20	0.530	100

See next page



Insulated cable end-sleeves to DIN with Easy-Entry, colour code 2

Nominal cross section mm ²	Part No.	Colour	Hint	Dimension mm					Weight/1000 pcs. ~ kg	Packing unit/pcs
				d1	d3	l1	l2	s1		
10	17612	■		4.5	8.4	22.0	12	0.20	0.550	100
	17618	■		4.5	8.4	28.0	18	0.20	0.710	100
16	17712	□		5.8	9.6	24.0	12	0.20	0.660	100
	17718	□		5.8	9.6	28.0	18	0.20	0.850	100
25	17816	■		7.3	12.0	30.0	16	0.20	1.500	50
	17818	■		7.3	12.0	30.0	18	0.20	1.550	50
	17822	■		7.3	12.0	36.0	22	0.20	2.000	50

Insulated cable end-sleeves with lug



- ▶ For fine and superfine stranded conductors, e.g. to DIN EN 60228 Cl. 5 and 6
- ▶ With identification system for max. 6 identification rings

Characteristics

- Dimensions to DIN 46228, part 4
- Insulated, halogen-free
- Heat resistant to 105° C

Material

- Copper (EN13600)
- Synthetic material: polypropylene

Surface

- Tin-plated to protect against corrosion

Technical instructions

- Tool: see page 150

Nominal cross section mm ²	Part No.	Colour	Dimension mm					Weight/1000 pcs. ~ kg	Packing unit/pcs
			d1	d3	l1	l2	s1		
0.5	3698	□	1.0	3.1	13.0	8	0.15	0.16	1000
0.75	3708	■	1.2	3.2	13.5	8	0.15	0.16	1000
1	3718	■	1.4	3.4	13.5	8	0.15	0.18	1000
1.5	3728	■	1.7	3.9	13.5	8	0.15	0.20	1000
2.5	3738	■	2.2	4.7	14.5	8	0.15	0.22	1000

Designation ring and insert fork



► For identifying the insulated cable end-sleeves with lugs

Characteristics

- Differing numbers / letters in the designation rings
- Packaging unit in booklet format, 200 of each symbol
- Insert fork A300 for inserting in the designation ring on the insulated cable end-sleeves with tabs

Additional information

- * = without letters "I" and "O"

Part No.	Colour	Hint	Packing unit/pcs
Designation rings			
380/-	■		1 Heft
380/+	■		1 Heft
380/0 bis 9	■		1 Heft
380/A bis Z	■	*	1 Heft
Insert fork			
A300			1

Insulated cable end-sleeves for short circuit resistant conductors

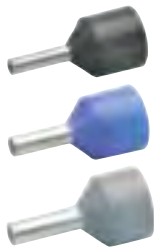

► For fine and superfine stranded conductors, e.g. to DIN EN 60228 Cl. 5 and 6
► For short circuit resistant conductors (e.g. NSGAFÖU)



Characteristics

- Insulated, halogen-free
- Heat resistant to 105° C
- Easy-Entry insulation for simple cable insertion
- Colour-coded cross-section assignment



Material

- Copper (EN13600)
- Synthetic material: polypropylene

Surface

- Tin-plated to protect against corrosion

Technical instructions

- Tool: see page 150

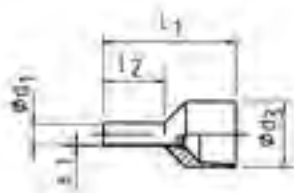

Nominal cross section mm ²	Part No.	Colour	Dimension mm					Weight/ 1000 pcs. ~ kg	Packing unit/pcs
			d1	d3	l1	l2	s1		
1.5	4328	■	1.7	8.1	17.5	8	0.15	0.22	100
	43210	■	1.7	8.1	19.5	10	0.15	0.27	100
2.5	4338	■	2.2	8.6	17.5	8	0.15	0.24	100
	43312	■	2.2	8.6	21.5	12	0.15	0.36	100
4	43410	■	2.9	10.5	19.5	10	0.20	0.36	100
6	43512	■	3.5	11.0	23.0	12	0.20	0.49	100
10	43612	■	4.5	12.5	24.0	12	0.20	0.65	100
16	43712	■	5.8	14.5	25.5	12	0.20	0.93	100



Insulated twin cable end-sleeves

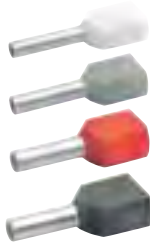

- ▶ For fine and superfine stranded conductors, e.g. to DIN EN 60228 Cl. 5 and 6
- ▶ For looping of clamps
- ▶ Colour-coding following DIN 46228 part 4 (0.5 - 16 mm²)

Characteristics

- Insulated, halogen-free
- Heat resistant to 105° C

Material

- Copper (EN13600)
- Synthetic material: polypropylene

Surface

- Tin-plated to protect against corrosion

Technical instructions

- Tool: see page 153

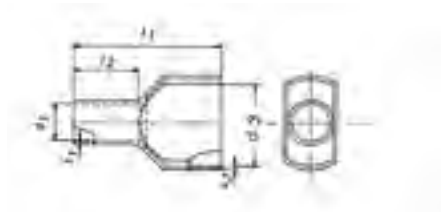

Nominal cross section mm ²	Part No.	Colour	Dimension mm						Weight/ 1000 pcs. ~ kg	Packing unit/ pcs
			d1	d3	l1	l2	s1	s2		
2 x 0.25	8678		1.20	2.3/3.9	15.0	8	0.15	0.25	0.110	1000
2 x 0.34	8688		1.20	2.3/3.9	15.0	8	0.15	0.25	0.110	1000
2 x 0.5	8698		1.40	3.0/5.2	15.0	8	0.15	0.25	0.110	1000
2 x 0.75	8708		1.70	3.3/5.5	15.0	8	0.15	0.25	0.130	1000
	87010		1.70	3.3/5.5	17.0	10	0.15	0.25	0.150	1000
2 x 1	8718		2.00	4.0/6.0	15.0	8	0.15	0.30	0.170	1000
	87110		2.00	4.0/6.0	17.0	10	0.15	0.30	0.170	1000
2 x 1.5	8728		2.20	4.2/7.2	16.0	8	0.15	0.30	0.183	1000
	87212		2.20	4.2/7.2	20.0	12	0.15	0.30	0.237	1000
2 x 2.5	87310		2.80	4.8/8.4	18.5	10	0.20	0.30	0.312	100
	87313		2.80	4.8/8.4	21.5	13	0.20	0.30	0.340	100
2 x 4	87412		3.70	5.7/9.6	23.0	12	0.20	0.40	0.467	100
2 x 6	87514		4.80	7.7/10.8	26.0	14	0.20	0.40	0.730	100
2 x 10	87614		6.40	8.0/13.8	26.0	14	0.20	0.40	0.884	100
2 x 16	87714		8.20	10.4/19.2	30.0	14	0.20	0.40	1.273	100

Insulated cable end-sleeves, strip form

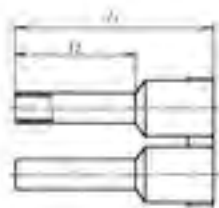
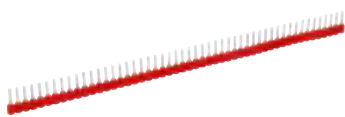

- ▶ For fine and superfine stranded conductors, e.g. to DIN EN 60228 Cl. 5 and 6
- ▶ Crimped cable end-sleeves for simple mounting to cable clamps



Characteristics

- Colour-coding and tube dimension to DIN 46228, part 4
- Insulated, halogen-free
- Heat resistant to 105° C



Material

- Copper (EN13600)
- Synthetic material: polypropylene

Surface

- Tin-plated to protect against corrosion

Nominal cross section mm ²	Part No.	Colour	Dimension mm		Weight/ 1000 pcs. ~ kg	Packing unit/pcs
			l1	l2		
0.5	ST9698		14	8	0.100	500
0.75	ST9708		14	8	0.100	500
1	ST9718		14	8	0.100	500
1.5	ST9728		14	8	0.100	500
2.5	ST9738		14	8	0.100	500

Insulated cable end-sleeves, small coil



- ▶ For fine and superfine stranded conductors, e.g. to DIN EN 60228 Cl. 5 and 6
- ▶ Easy-Entry insulation for optimal cable insertion
- ▶ Automatic processing due to coil shape



Characteristics

- Colour-coding and tube dimension to DIN 46228, part 4
- Insulated, halogen-free
- Heat resistant to 105° C



Material

- Copper (EN13600)
- Synthetic material: polypropylene

Surface

- Tin-plated to protect against corrosion

Nominal cross section mm ²	Part No.	Colour	Dimension mm		Weight/ 1000 pcs. ~ kg	Packing unit/pcs
			l1	l2		
0.5	BAK9698		14	8	0.136	1100
0.75	BAK9708		14	8	0.154	1100
1	BAK9718		14	8	0.187	800
1.5	BAK9728		14	8	0.200	800
2.5	BAK9738		14	8	0.300	500



Insulated cable end-sleeves, large coil



- ▶ For fine and superfine stranded conductors, e.g. to DIN EN 60228 Cl. 5 and 6
- ▶ Easy-Entry insulation for splice-free cable insertion
- ▶ Automatic processing due to coil shape



Characteristics

- Colour-coding and tube dimension to DIN 46228, part 4
- Insulated, halogen-free
- Heat resistant to 105° C



Material

- Copper (EN13600)
- Synthetic material: polypropylene

Surface

- Tin-plated to protect against corrosion

Nominal cross section mm ²	Part No.	Colour	Dimension mm		Weight/ 1000 pcs. ~ kg	Packing unit/pcs
			l1	l2		
0.5	BAG9698	□	14	8	0.120	10000
0.75	BAG9708	■	14	8	0.130	10000
1	BAG9718	■	14	8	0.160	7500
1.5	BAG9728	■	14	8	0.173	7500
2.5	BAG9738	■	14	8	0.230	5000

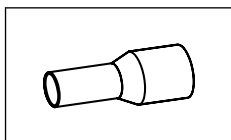

Tool application chart

Cable end-sleeves to DIN 46228, part 1 and DIN 46228, part 4 Insulated cable end-sleeves for short circuit resistant conductors

Part 1 of 2

Tool type	Crimping range corresponds to nominal cross-section mm ²	Crimping Tool		Catalogue page		Crimp profile
		Part No.	Crimping head / adapter	Crimping Tool	Crimping die	
Mechanical crimping tools	0.08-10	K303		217		
		K304K		217		
		K306K		217		
	0.14-2.5	K1		212		
		K48		212		
	0.14-6	K32		213		
		K37		214		
	0.14-10	K3014K		218		
	0.25-6	K38ERGO		216		
	0.5-2.5	K4		210		
	0.5-6	K36		213		
		K382		215		
	0.5-16	K3		211		
	1.5-6	K46		210		
	6-16	K34		214		
	10-25	K39		215		
	10-35	K35		211		
	10-50	K271		218		
		K28		219		
	50-95	K272		219		
K29			220			
Mechanical, electrical, pneumatic crimping tools with interchangeable die / head	0.14-10	K507		243		
		KP1	+KP303	240		
		KP1L	+KP303	240		
	0.14-50	K50		244	326	
		EK50ML		254	326	
	1.5-6	KP1	+KP351	240		
		KP1L	+KP351	240		
	2.5-16	KP1	+KP304	240		
		KP1L	+KP304	240		
	10-16	KP1	+KP352	240		
		KP1L	+KP352	240		
	10-50	K354		246	332	
	10-95	K18		248	340	
	10-240	K22		250	346	

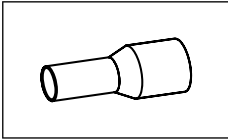

Tool application chart

Cable end-sleeves to DIN 46228, part 1 and DIN 46228, part 4
Insulated cable end-sleeves for short circuit resistant conductors

Part 2 of 2

Tool type	Crimping range corresponds to nominal cross-section mm ²	Crimping Tool		Catalogue page		Crimp profile		
		Part No.	Crimping head / adapter	Crimping Tool	Crimping die			
Hand hydraulic crimping tools	10-95	HK6018		292	340			
		HK60UNV	+UA18	473	340			
	10-240	HK6022		294	346			
		HK60UNV	+UA22	473	351			
	25-240	HK12030		298	351			
		HK12042		300	351			
		HK120U		302				
	Battery powered crimping tools	0.14-10	EKP1ML	+KP303	260			
		0.14-50	EK1550ML		258			
1.5-6		EKP1ML	+KP351	260				
2.5-16		EKP1ML	+KP304	260				
10-16		EKP1ML	+KP352	260				
10-50		EK354ML		262	332			
		EK354		266	332			
		EK505		268	326			
10-95		EK5018		270	340			
		EK60UNV	+UA18	476	340			
		EKM60UNV	+UA18	475	340			
10-240		EK6022		274	346			
		EKM6022		272	346			
		EK60UNV	+UA22	476	346			
		EKM60UNV	+UA22	475	346			
25-240		EK12032		280	351			
		EK12042		282	351			
		EK120U		284	351			
		EK135FT	+UA15T	286	351			
		EK120UNV	+UA12T	284	351			
Hydraulic crimping systems	10-95	THK18		306	340			
	10-150	THK22		308	346			
	25-240	HK252		320	357			
Hydraulic crimping heads	10-95	PK18		306	340			
		PK60UNV	+UA18	474	340			
	10-240	PK22		308	346			
		PK60UNV	+UA22	474	346			
	25-240	PK12042		312	351			
		PK120U		314	351			
		PK252		316	357			

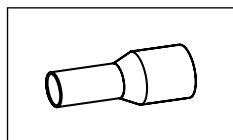

Tool application chart

Cable end-sleeves acc. to DIN 46228, part 2

Tool type	Crimping range corresponds to nominal cross-section mm ²	Crimping Tool		Catalogue page		Crimp profile
		Part No.	Crimping head / adapter	Crimping Tool	Crimping die	
Mechanical, electrical, pneumatic crimping tools with interchangeable die / head	0.5x2.5	KP1	+KP66	240		☺
		KP1L	+KP66	240		☺
		KPM15	+KP66			☺
Battery powered crimping tools	0.5x2.5	EKP1ML	+KP66	260		☺

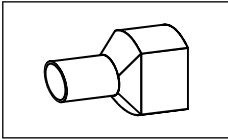

Tool application chart

Insulated twin cable end-sleeves

Tool type	Crimping range corresponds to nominal cross-section mm ²	Crimping Tool		Catalogue page		Crimp profile
		Part No.	Crimping head / adapter	Crimping Tool	Crimping die	
Mechanical crimping tools	2x0.5 - 2x2.5	K32		213		
		K382		215		
		K38ERGO		216		
	2x0.5 - 2x4	K303		217		
		K36		213		
	2x0.5 - 2x6	K306K		217		
		K304K		217		
		K3014K		218		
	2x4 - 2x6	K34		214		
	2x4 - 2x16	K271		218		
		K28		219		
Mechanical, electrical, pneumatic crimping tools with interchangeable die / head	2x0.5 - 2x4	KP1	+KP303	240		
		KP1L	+KP303	240		
	2x4 - 2x6	KP1		240		
	2x4 - 2x16	K354		246	332	
		K18		248	340	
K22		250	346			
Hand hydraulic crimping tools	2x4 - 2x16	HK6018		292	340	
		HK60UNV	+UA18	473	340	
		HK6022		294	346	
		HK60UNV	+UA22	473	346	
Battery powered crimping tools	2x0.5 - 2x4	EKP1ML	+KP303	260		
	2x4 - 2x6	EKP1ML	+KP304	260		
	2x4 - 2x16	EK354ML		262	346	
		EK354		266	346	
		EK505		268	336	
		EK5018		270	340	
		EK60UNV	+UA18	476	340	
		EKM60UNV	+UA18	475	340	
		EK6022		274	346	
		EKM6022		272	346	
		EK60UNV	+UA22	476	346	
EKM60UNV		+UA22	475	346		
Hydraulic crimping systems	2x4-2x16	THK18		306	340	
		THK22		308	346	
Hydraulic crimping heads	2x4-2x16	PK18		306	340	
		PK60UNV	+UA18	474	340	
		PK22		308	346	
		PK60UNV	+UA22	474	346	

PRECISION - CABLE CONNECTIONS, INSULATED AND NON-INSULATED

Electrical power is the product of voltage and current strength. An optimum connection guarantees to transfer this power without thermal losses. This requires materials, design and tool to be correctly processed and matched to one another. If you want optimum power at all times, you can rely on Klauke's best work.



In brief

- ▶ High requirements in detail
- ▶ Solutions available for small cross-sections
- ▶ Broad range of versions
- ▶ Optimum connection without thermal loss
- ▶ Grooved profile for improved conductor hold



► Easy insulation

All insulation is produced in the Easy-Entry version, for simple cable insertion without splicing. For small ranges with big effect.

- Cable connections with nominal cross-sections from 0.1 mm² to 6 mm²
- Resistant to temperatures of up to 105 °C

- Flame retardant polyamide insulation: No toxic vapours in case of fire
- Halogen-free
- Insensitive to corrosion due to tinning under the insulation
- Simple processing thanks to Easy-Entry
- Grooved profile on the inside for improved hold

► More hold with grooved profile

The detail is key. Not only are there numerous models of Klauke tabs and receptacles, they are also equipped with special features. No matter whether as a standardised connector or with grooved profile for improved hold - Klauke will always provide the right feature for your requirements.

- Broad range of models
- All-purpose
- Also as standardised connectors with various tab widths
- Available with strain relief
- Fully-insulated receptacles
- Grooved profile and additional copper ring in the insulation area for higher stresses



► Quality in detail

In a machine, everything has to pull together. For the machine to run, every component has to function. Even when it comes to small parts, better to go for high quality products with a high capacity, for our receptacles with snap-in point for example. The snap-in point guarantees a reliable connection even after repeated insertions.

- High conductivity and reliable insulation thanks to high-quality materials
- Improved spring properties by the use of bronze



Insulated solderless terminals



- ▶ For fine and superfine stranded conductors, e.g. to DIN EN 60228 Cl. 5 and 6
- ▶ To DIN 46237
- ▶ High-quality brazing process in the crimp area

Characteristics

- Insulated, halogen-free
- Heat resistant to 105° C
- Easy-Entry insulation for simple cable insertion
- Cross-section-dependent colour-coding

Material

- Copper (ETP)
- Insulation sleeve: PA

Surface

- Tin-plated to protect against corrosion

Technical instructions

- Tool: see page 175

Additional information

- * = not standardised
- 0.1 - 0.4 mm² not CSA-tested

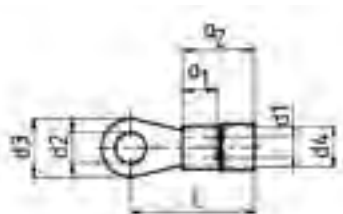

Nominal cross section mm ²	Nominal size to DIN	Part No.	Colour	Hint	Dimension mm								Weight/ pcs. ~kg	Packing unit/pcs	
					a1	a2	d1	d2	d3	d4	l	s			
0.1 - 0.4	--	6192	□	*	--	--	1.0	2.3	5.0	2.2	14.0	0.5	0.020	100	
	--	61925	□	*	--	--	1.0	2.6	5.0	2.2	14.0	0.5	0.020	100	
	--	6193	□	*	--	--	1.0	3.3	5.0	2.2	14.0	0.5	0.020	100	
	--	61935	□	*	--	--	1.0	3.8	6.5	2.2	16.0	0.5	0.025	100	
	--	6194	□	*	--	--	1.0	4.4	7.0	2.2	16.0	0.5	0.025	100	
	--	6195	□	*	--	--	1.0	5.4	8.0	2.2	15.0	0.5	0.025	100	
0.5 - 1	2.5 - 1	62025	■			5	10.5	1.6	2.8	6.0	4.5	16.5	0.8	0.060	100
	3.0 - 1	6203	■			5	10.5	1.6	3.2	6.0	4.5	16.5	0.8	0.060	100
	3.5 - 1	62035	■			5	10.5	1.6	3.7	6.0	4.5	16.5	0.8	0.550	100
	4.0 - 1	6204	■			5	10.5	1.6	4.3	8.0	4.5	17.5	0.8	0.070	100
	5.0 - 1	6205	■			5	10.5	1.6	5.3	10.0	4.5	18.5	0.8	0.090	100
	--	6206	■	*		5	10.5	1.6	6.5	11.0	4.5	20.5	0.8	0.080	100
1.5 - 2.5	--	6208	■	*		5	10.5	1.6	8.4	14.0	4.5	22.5	0.8	0.130	100
	--	62010	■	*		5	10.5	1.6	10.5	18.0	4.5	24.5	0.8	0.130	100
	3.0 - 2.5	6303	■			5	11.5	2.3	3.2	6.0	5.1	17.5	0.8	0.065	100
	3.5 - 2.5	63035	■			5	11.5	2.3	3.7	6.0	5.1	17.5	0.8	0.065	100
	4.0 - 2.5	6304	■			5	11.5	2.3	4.3	8.0	5.1	18.5	0.8	0.080	100
	5.0 - 2.5	6305	■			5	11.5	2.3	5.3	10.0	5.1	20.5	0.8	0.090	100
4 - 6	6.0 - 2.5	6306	■			5	11.5	2.3	6.5	11.0	5.1	22.5	0.8	0.110	100
	8.0 - 2.5	6308	■			5	11.5	2.3	8.4	14.0	5.1	23.5	0.8	0.130	100
	--	63010	■	*		5	11.5	2.3	10.5	18.0	5.1	25.5	0.8	0.160	100
	4.0 - 6	6504	■			6	12.5	3.6	4.3	8.0	6.5	20.5	1.0	0.140	100
	5.0 - 6	6505	■			6	12.5	3.6	5.3	10.0	6.5	21.5	1.0	0.160	100
	6.0 - 6	6506	■			6	12.5	3.6	6.5	11.0	6.5	22.5	1.0	0.170	100
4 - 6	8.0 - 6	6508	■			6	12.5	3.6	8.4	14.0	6.5	25.5	1.0	0.220	100
	10.0 - 6	65010	■			6	12.5	3.6	10.5	18.0	6.5	27.5	1.0	0.290	100



Insulated solderless terminals, fork type



- ▶ For fine and superfine stranded conductors, e.g. to DIN EN 60228 Cl. 5 and 6
- ▶ Dimensions in the crimp area to DIN 46237
- ▶ High-quality brazing process in the crimp area
- ▶ Simple fork-type mounting

Characteristics

- Insulated, halogen-free
- Heat resistant to 105° C
- Easy-Entry insulation for simple cable insertion
- Cross-section-dependent colour-coding

Material

- Copper (ETP)
- Insulation sleeve: PA

Surface

- Tin-plated to protect against corrosion

Technical instructions

- Tool: see page 175

Additional information

- 0.1 - 0.4 mm² not CSA-tested
- * = not standardised

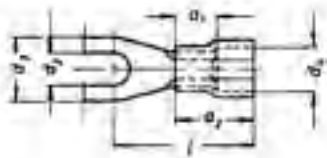

Nominal cross section mm ²	Nominal size to DIN	Part No.	Colour	Hint	Dimension mm								Weight/ pcs. ~kg	Packing unit/pcs
					a1	a2	d1	d2	d3	d4	l	s		
0.1 - 0.4	--	619C3	■	*	--	--	--	3.2	5.0	--	14.0	0.5	0.020	100
	3.0 - 1	620C3	■		5	10.5	1.6	3.2	6.0	4.5	16.5	0.8	0.060	100
	3.5 - 1	620C35	■		5	10.5	1.6	3.7	6.8	4.5	17.5	0.8	0.060	100
0.5 - 1	4.0 - 1	620C4	■		5	10.5	1.6	4.3	6.8	4.5	17.5	0.8	0.070	100
	5.0 - 1	620C5	■		5	10.5	1.6	5.3	10.0	4.5	18.5	0.8	0.090	100
	--	620C6	■	*	5	10.5	1.6	6.5	11.0	4.5	20.5	0.8	0.080	100
	3.0 - 2.5	630C3	■		5	11.5	2.3	3.2	6.0	5.1	17.5	0.8	0.060	100
	3.5 - 2.5	630C35	■		5	11.5	2.3	3.7	6.8	5.1	18.5	0.8	0.065	100
1.5 - 2.5	4.0 - 2.5	630C4	■		5	11.5	2.3	4.3	6.8	5.1	18.5	0.8	0.080	100
	5.0 - 2.5	630C5	■		5	11.5	2.3	5.3	10.0	5.1	20.5	0.8	0.090	100
	6.0 - 2.5	630C6	■		5	11.5	2.3	6.5	11.0	5.1	22.5	0.8	0.110	100
	4.0 - 6	650C4	■		6	12.5	3.6	4.3	8.0	6.5	20.5	1.0	0.140	100
	5.0 - 6	650C5	■		6	12.5	3.6	5.3	10.0	6.5	21.5	1.0	0.160	100
4 - 6	6.0 - 6	650C6	■		6	12.5	3.6	6.5	11.0	6.5	22.5	1.0	0.170	100
	8.0 - 6	650C8	■		6	12.5	3.6	8.4	14.0	6.5	25.5	1.0	0.220	100
	10.0 - 6	650C10	■		6	12.5	3.6	10.5	18.0	6.5	27.5	1.0	0.280	100



Insulated pin terminals



- ▶ For fine and superfine stranded conductors, e.g. to DIN EN 60228 Cl. 5 and 6
- ▶ To DIN 46231
- ▶ High-quality brazing process in the crimp area

Characteristics

- Insulated, halogen-free
- Cross-section-dependent colour-coding
- Heat resistant to 105° C
- Easy-Entry insulation for simple cable insertion

Material

- Copper (ETP)
- Insulation sleeve: PA

Surface

- Tin-plated to protect against corrosion

Technical instructions

- Tool: see page 175

Additional information

- 0.1 - 0.4 mm² not CSA-tested
- * = not standardised

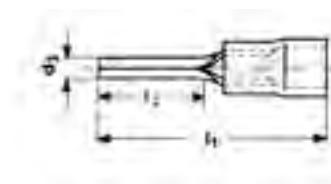

Nominal cross section mm ²	Nominal size to DIN	Part No.	Colour	Hint	Dimension mm						Weight/ pcs. ~kg	Packing unit/pcs
					a1	a2	d3	d4	l1	l2		
0.1 - 0.4	--	704	■	*	--	--	1.4	--	18.0	9.0	0.020	100
0.5 - 1	1	705	■		5	10.5	1.9	4.5	22.0	10.0	0.065	100
		705K	■	*	5	10.5	1.9	4.5	18.0	6.0	0.060	100
1.5 - 2.5	2.5	710	■		5	11.5	1.9	5.1	23.0	10.0	0.065	100
		710K	■	*	5	11.5	1.9	5.1	19.5	6.5	0.060	100
		710L	■	*	5	11.5	1.9	5.1	27.5	16.0	0.100	100
4 - 6	6	715	■		6	12.5	2.7	6.5	26.0	11.0	0.160	100



Insulated pin receptacles



- ▶ For fine and superfine stranded conductors, e.g. to DIN EN 60228 Cl. 5 and 6
- ▶ High quality bronze material provides optimum spring characteristic and improved contact strength

Characteristics

- Cross-section-dependent colour-coding
- Heat resistant to 70° C

Material

- Bronze (CuSnZn)
- Insulation sleeve: PVC

Surface

- Tin-plated to protect against corrosion

Technical instructions

- Tool: see page 175

Additional information

- 1.5 - 2.5 mm² and 4 - 6 mm² not CSA-tested

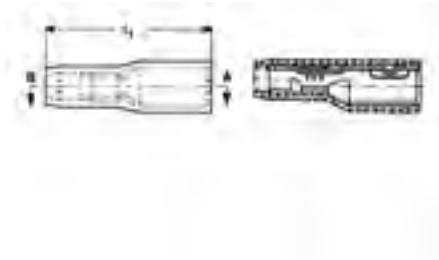

Nominal cross section mm ²	Part No.	Colour	Dimension mm		Weight/pcs. ~kg	Packing unit/pcs
			Pin dia.	l1		
0.5 - 1	920	■	4	22	0.060	100
1.5 - 2.5	930	■	5	22	0.120	100
4 - 6	950	■	5	22	0.125	100

Insulated pin receptacles



- ▶ For fine and superfine stranded conductors, e.g. to DIN EN 60228 Cl. 5 and 6

Characteristics

- Cross-section-dependent colour-coding
- Heat resistant to 70° C

Material

- Brass (CuZn)
- Insulation sleeve: PVC

Surface

- Tin-plated to protect against corrosion

Technical instructions

- Tool: see page 175

Additional information

- 1.5 - 2.5 mm² and 4 - 6 mm² not CSA-tested

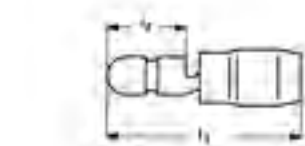

Nominal cross section mm ²	Part No.	Colour	Dimension mm			Weight/pcs. ~kg	Packing unit/pcs
			Pin dia.	l1	l2		
0.5 - 1	1020	■	4	22	9	0.060	100
1.5 - 2.5	1030	■	5	22	9	0.075	100
4 - 6	1050	■	5	22	9	0.110	100



Insulated pin receptacles, fully insulated



- ▶ For fine and superfine stranded conductors, e.g. to DIN EN 60228 Cl. 5 and 6
- ▶ High quality bronze material provides optimum spring characteristic and improved contact strength
- ▶ Fast processing as no additional insulation of the crimped connection is required

Characteristics

- Insulated, halogen-free
- Cross-section-dependent colour-coding
- Heat resistant to 105° C

Material

- Bronze (CuSnZn)
- Insulation sleeve: PA

Surface

- Tin-plated to protect against corrosion

Technical instructions

- Tool: see page 175

Additional information

- 4 - 6 mm² not CSA-tested

Nominal cross section mm ²	Part No.	Colour	Dimension mm			Weight/pcs. ~kg	Packing unit/pcs
			Pin dia.	l1	s		
0.5 - 1	920V	■	4	24	0.38	0.065	100
4 - 6	950V	■	5	27	0.40	0.150	100

Insulated pin receptacles, fully insulated



- ▶ For fine and superfine stranded conductors, e.g. to DIN EN 60228 Cl. 5 and 6
- ▶ High quality bronze material provides optimum spring characteristic and improved contact strength
- ▶ Fast processing as no additional insulation of the crimped connection is required

Characteristics

- Insulated, halogen-free
- Cross-section-dependent colour-coding
- Heat resistant to 105° C

Material

- Bronze (CuSnZn)
- Insulation sleeve: PA

Surface

- Tin-plated to protect against corrosion

Technical instructions

- Tool: see page 175

Additional information

- 1.5 - 2.5 mm² and 4 - 6 mm² not CSA-tested

Nominal cross section mm ²	Part No.	Colour	Dimension mm			Weight/pcs. ~kg	Packing unit/pcs
			Pin dia.	l1	l2		
0.5 - 1	1020V	■	4	25	11	0.065	100
1.5 - 2.5	1030V	■	5	25	11	0.080	100
4 - 6	1050V	■	5	27	13	0.120	100



Insulated receptacles, tinned brass



► For fine and superfine stranded conductors, e.g. to DIN EN 60228 Cl. 5 and 6

Characteristics

- To DIN 46245, part 1 – 3 and similar versions
- Insulated, halogen-free
- Cross-section-dependent colour-coding
- Temperature resistance: PVC to 70° C, PA to 105° C

Material

- Brass (CuZn)
- Insulation sleeve: PVC/PA

Surface

- Tin-plated to protect against corrosion

Technical instructions

- Tool: see page 175

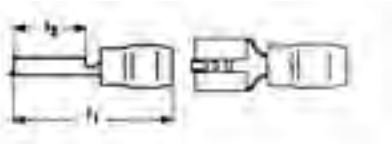

Nominal cross section mm ²	Nominal size to DIN	Part No.	Colour	Tab Thickn.	Tab Width	Dimension mm		Insulation material	Weight/pcs. ~kg	Packing unit/pcs
						l1	l2			
0.5 - 1		8201	■	0.5	2.8	17.5	8.0	PVC	0.035	100
		8201A	■	0.8	2.8	17.5	8.0	PVC	0.045	100
	4.8 - 1	8202	■	0.5	4.8	18.0	6.0	PVC	0.065	100
		8203	■	0.8	4.8	18.0	6.0	PVC	0.065	100
	6.3 - 1	720	■	0.8	6.3	22.0	7.5	PVC	0.090	100
		7208	■	0.8	7.7	25.0	9.5	PVC	0.110	100
1.5 - 2.5		8301	■	0.5	2.8	18.0	8.0	PA	0.050	100
		8301A	■	0.8	2.8	18.0	8.0	PA	0.060	100
	4.8 - 2.5	8302	■	0.5	4.8	18.0	6.0	PVC	0.070	100
		8303	■	0.8	4.8	18.0	6.0	PVC	0.070	100
	6.3 - 2.5	730	■	0.8	6.3	21.0	7.4	PVC	0.090	100
		7308	■	0.8	7.7	25.0	9.5	PVC	0.115	100
4 - 6	6.3 - 6	8503	■	0.8	4.8	23.0	7.5	PA	0.138	100
		750	■	0.8	6.3	21.0	7.5	PVC	0.100	100
		7509	■	1.2	9.5	26.5	12.0	PVC	0.150	100

Insulated receptacles, tinned bronze



- ▶ For fine and superfine stranded conductors, e.g. to DIN EN 60228 Cl. 5 and 6
- ▶ High quality bronze material provides optimum spring characteristic and improved contact strength

Characteristics

- To DIN 46245, part 3
- Cross-section-dependent colour-coding
- Heat resistant to 70° C

Material

- Bronze (CuSnZn)
- Insulation sleeve: PVC

Surface

- Tin-plated to protect against corrosion

Technical instructions

- Tool: see page 175

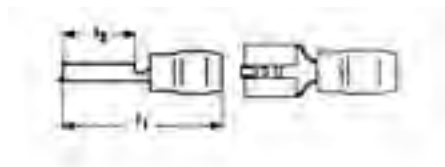

Nominal cross section mm ²	Nominal size to DIN	Part No.	Colour	Tab Thickn.	Tab Width	Dimension mm		Insulation material	Weight/pcs. ~kg	Packing unit/ pcs
						l1	l2			
0.5 - 1	6.3 - 1	720BZ	■	0.8	6.3	22	7.5	PVC	0.09	100
1.5 - 2.5	6.3 - 2.5	730BZ	■	0.8	6.3	21	7.4	PVC	0.09	100
4 - 6	6.3 - 6	750BZ	■	0.8	6.3	21	7.5	PVC	0.10	100

Insulated receptacles, multiple type



- ▶ For fine and superfine stranded conductors, e.g. to DIN EN 60228 Cl. 5 and 6

Characteristics

- Cross-section-dependent colour-coding
- Heat resistant to 70° C

Material

- Brass (CuZn)
- Insulation sleeve: PVC

Surface

- Tin-plated to protect against corrosion

Technical instructions

- Tool: see page 175

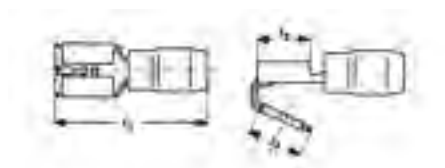

Nominal cross section mm ²	Part No.	Colour	Tab Thickn.	Tab Width	Dimension mm			Insulation material	Weight/pcs. ~kg	Packing unit/ pcs
					l1	l2	l3			
0.5 - 1	720AZ	■	0.8	6.3	22	7.5	8	PVC	0.11	100
1.5 - 2.5	730AZ	■	0.8	6.3	22	7.5	8	PVC	0.11	100
4 - 6	750AZ	■	0.8	6.3	25	8.0	8	PVC	0.18	100



Insulated receptacles, fully insulated



- ▶ For fine and superfine stranded conductors, e.g. to DIN EN 60228 Cl. 5 and 6
- ▶ Fast processing as no additional insulation of the crimped connection is required

Characteristics

- Insulated, halogen-free
- Cross-section-dependent colour-coding
- Temperature resistance: PVC to 70° C, PA to 105° C

Material

- Brass (CuZn)
- Insulation sleeve: PVC/PA

Surface

- Tin-plated to protect against corrosion

Technical instructions

- Tool: see page 175

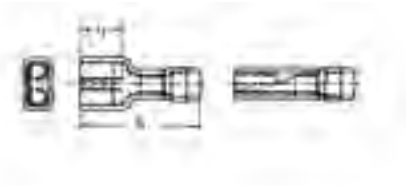

Nominal cross section mm ²	Part No.	Colour	Tab Thickn.	Tab Width	Dimension mm		Insulation material	Weight/pcs. ~kg	Packing unit/pcs
					l1	l2			
0.5 - 1	8201V	■	0.5	2.8	19.0	5.5	PA	0.07	100
	8201AV	■	0.8	2.8	19.0	5.5	PA	0.07	100
	8202V	■	0.5	4.8	20.0	7.0	PVC	0.10	100
	8203V	■	0.8	4.8	20.0	7.0	PVC	0.10	100
	720V	■	0.8	6.3	21.0	7.5	PVC	0.08	100
1.5 - 2.5	8301V	■	0.5	2.8	20.0	8.0	PVC	0.14	100
	8301AV	■	0.8	2.8	20.0	8.0	PVC	0.14	100
	8302V	■	0.5	4.8	20.5	7.0	PVC	0.11	100
	8303V	■	0.8	4.8	20.5	7.0	PVC	0.11	100
	730V	■	0.8	6.3	21.0	7.5	PVC	0.15	100
4 - 6	8502V	■	0.5	4.8	20.5	9.5	PVC	0.15	100
	8503V	■	0.8	4.8	20.5	9.5	PVC	0.15	100
	750V	■	0.8	6.3	25.5	11.5	PVC	0.16	100

Insulated tabs



► For fine and superfine stranded conductors, e.g. to DIN EN 60228 Cl. 5 and 6

Characteristics

- Insulated, halogen-free
- Cross-section-dependent colour-coding
- Temperature resistance: PVC to 70° C, PA to 105° C

Material

- Brass (CuZn)
- Insulation sleeve: PVC/PA

Surface

- Tin-plated to protect against corrosion

Technical instructions

- Tool: see page 175

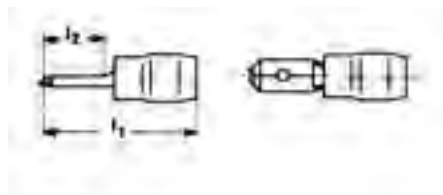

Nominal cross section mm ²	Part No.	Colour	Tab Thickn.	Tab Width	Dimension mm		Insulation material	Weight/pcs. ~kg	Packing unit/pcs
					l1	l2			
0.5 - 1	8201C	■	0.5	2.8	22.0	11.5	PA	0.040	100
	8201B	■	0.8	2.8	14.6	5.5	PVC	0.060	100
	8202B	■	0.5	4.8	22.0	11.5	PA	0.070	100
	8203B	■	0.8	4.8	22.0	11.5	PA	0.070	100
	820	■	0.8	6.3	22.0	8.0	PVC	0.060	100
1.5 - 2.5	8302B	■	0.5	4.8	22.0	11.5	PA	0.070	100
	8303B	■	0.8	4.8	22.0	11.5	PA	0.070	100
	830	■	0.8	6.3	22.0	8.0	PVC	0.065	100
4 - 6	8502B	■	0.5	4.8	24.5	10.5	PA	0.120	100
	8503B	■	0.8	4.8	24.5	10.5	PA	0.120	100
	850	■	0.8	6.3	22.0	8.0	PVC	0.110	100

Insulated end-splices



► For fine and superfine stranded conductors, e.g. to DIN EN 60228 Cl. 5 and 6
 ► Safe sealing of open conductors

Characteristics

- Insulated, halogen-free
- Cross-section-dependent colour-coding
- Heat resistant to 105° C

Material

- Copper (ETP)
- Insulation sleeve: PA

Surface

- Tin-plated to protect against corrosion

Technical instructions

- Tool: see page 175

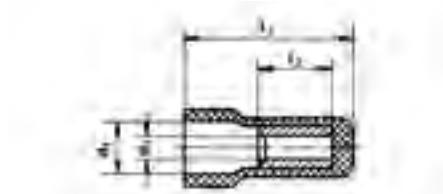

Nominal cross section mm ²	Part No.	Colour	Dimension mm				Weight/pcs. ~kg	Packing unit/pcs
			d1	d2	l1	l2		
1.5 - 2.5	1130	■	2.3	5.2	16	7	0.05	100
4 - 6	1150	■	3.6	7.0	18	7	0.14	100



Insulated butt connectors

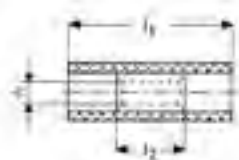

- ▶ For fine and superfine stranded conductors, e.g. to DIN EN 60228 Cl. 5 and 6
- ▶ Simple and safe connecting owed to butt mark
- ▶ Fast processing as no additional insulation of the crimped connection is required

Characteristics

- Insulated, halogen-free
- Cross-section-dependent colour-coding
- Heat resistant to 105° C

Material

- Copper (ETP)
- Insulation sleeve: PA

Surface

- Tin-plated to protect against corrosion

Technical instructions

- Tool: see page 175

Additional information

- 0.1 - 0.4 mm² not CSA-tested

Nominal cross section mm ²	Part No.	Colour	Dimension mm			Weight/pcs. ~kg	Packing unit/pcs
			d1	l1	l2		
0.1 - 0.4	669	Yellow	1.2	20	12	0.030	100
0.5 - 1	670	Red	1.6	25	15	0.090	100
1.5 - 2.5	680	Blue	2.3	25	15	0.115	100
4 - 6	700	Yellow	3.6	27	15	0.250	100

Insulated butt connectors with heat shrink insulation

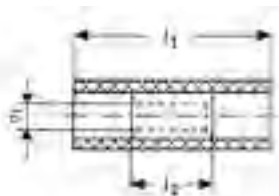

- ▶ For fine and superfine stranded conductors, e.g. to DIN EN 60228 Cl. 5 and 6
- ▶ Simple and safe processing due to butt mark
- ▶ Fast processing as no additional insulation of the crimped connection is required

Characteristics

- Insulated, halogen-free
- Cross-section-dependent colour-coding
- Special crimping tool required
- Heat resistant to 105° C

Material

- Copper (ETP)
- Insulation sleeve: PE

Surface

- Tin-plated to protect against corrosion

Technical instructions

- Tool: see page 175

Nominal cross section mm ²	Part No.	Colour	Dimension mm			Weight/pcs. ~kg	Packing unit/pcs
			d1	l1	l2		
0.5 - 1	670WS	Red	1.6	36	15	0.12	100
1.5 - 2.5	680WS	Blue	2.3	36	15	0.15	100
4 - 6	700WS	Yellow	3.4	41	15	0.25	100



Insulated parallel connectors



- ▶ For fine and superfine stranded conductors, e.g. to DIN EN 60228 Cl. 5 and 6
- ▶ Fast processing as no additional insulation of the crimped connection is required

Characteristics

- Insulated, halogen-free
- Cross-section-dependent colour-coding
- Heat resistant to 105° C

Material

- Copper (ETP)
- Insulation sleeve: PA

Surface

- Tin-plated to protect against corrosion

Technical instructions

- Tool: see page 175

Additional information

- 0.1 - 0.4 mm² not CSA-tested

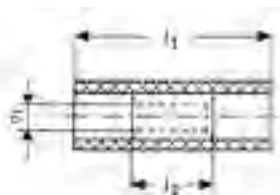

Nominal cross section mm ²	Part No.	Colour	Dimension mm			Weight/pcs. ~kg	Packing unit/pcs
			d1	l1	l2		
0.1 - 0.4	769		1.2	13	5	0.020	100
0.5 - 1	770		1.6	17	7	0.030	100
1.5 - 2.5	780		2.3	17	7	0.035	100
4 - 6	790		3.6	21	7	0.105	100



Non-insulated receptacles

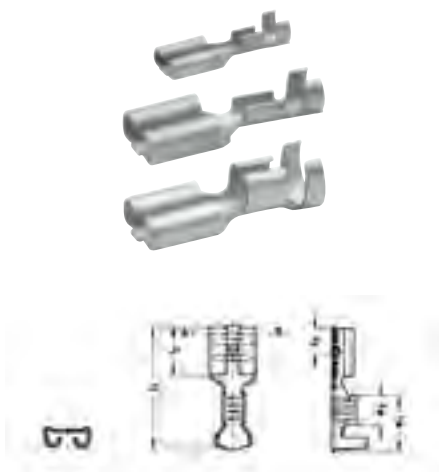

► For fine and superfine stranded conductors, e.g. to DIN EN 60228 Cl. 5 and 6



Characteristics

- To DIN 46247, part 1 – 3 and similar versions
- Improved contact properties due to grooved profile



Material

- Brass (CuZn)



Surface

- Tin-plated to protect against corrosion

Technical instructions

- Tool: see page 176

Additional information

- * = nickel-plated steel version also available, Part Number appendix “ST“

Nominal cross section mm ²	Nominal size to DIN	Part No.	Tab Thickn.	Tab Width	Dimension mm						Weight/ pcs. ~kg	Packing unit/pcs
					a1	a2	l1	l2	l3	s		
0.5 - 1	--	18251	0.5	2.8	5.0	2.8	12.5	5.0	3.3	0.30	0.025	100
	--	18251A	0.8	2.8	5.5	2.5	12.5	5.0	3.3	0.30	0.025	100
	B 2.8 - 1	18201A	0.8	2.8	5.5	2.5	14.0	6.3	3.3	0,35	0.025	100
	--	18202	0.5	4.8	6.0	3.4	15.6	6.0	3.8	0.35	0.050	100
	4.8 - 1	18203	0.8	4.8	6.0	3.4	15.6	6.0	3.8	0.35	0.050	100
1.5 - 2.5	6.3 - 1	1720	0.8	6.3	8.5	4.5	19.0	7.4	4.0	0.45	0.085	100
	4.8 - 2.5	18303	0.8	4.8	6.0	3.4	15.6	6.0	3.8	0.35	0.055	100
	6.3 - 2.5	*1730	0.8	6.3	8.5	4.5	19.0	7.4	4.0	0.45	0.082	100
4 - 6	6.3 - 6	*1750	0.8	6.3	8.5	4.5	19.0	7.4	4.0	0.45	0.100	100

Non-insulated receptacles, multiple type



► For fine and superfine stranded conductors, e.g. to DIN EN 60228 Cl. 5 and 6



Characteristics

- To DIN 46247, part 1 – 3 and similar versions
- Improved contact properties due to grooved profile



Material

- Brass (CuZn)



Surface

- Tin-plated to protect against corrosion

Technical instructions

- Tool: see page 176

Additional information

- * = corresponds to DIN 46345

Nominal cross section mm ²	Part No.	Tab Thickn.	Tab Width	Hint	Dimension mm						Weight/ pcs. ~kg	Packing unit/pcs
					a1	a2	l1	l2	l3	s		
0.5 - 1	18203AZ	0.8	4.8		6.0	3.4	15.6	7	6.0	0.38	0.09	100
1.5 - 2.5	18303AZ	0.8	4.8		6.0	3.4	15.6	7	6.0	0.38	0.09	100
	1730AZ	0.8	6.3	*	8.5	4.5	19.2	8	7.5	0.38	0.13	100

Non-insulated receptacles with locking latch



► For fine and superfine stranded conductors, e.g. to DIN EN 60228 Cl. 5 and 6



Characteristics

- To DIN 46340, sheet 3
- With latch to engage in housing
- Improved contact properties due to grooved profile



Material

- Brass (CuZn)



Surface

- Tin-plated to protect against corrosion

Technical instructions

- Tool: see page 176

Nominal cross section mm ²	Part No.	Tab Thickn.	Tab Width	Dimension mm						Weight/pcs. ~kg	Packing unit/pcs
				a1	a2	l1	l2	l3	s		
0.5 - 1	2720	0.8	6.3	8.5	4.5	19.2	7.4	7	0.38	0.070	100
1.5 - 2.5	2730	0.8	6.3	8.5	4.5	19.2	7.4	7	0.38	0.075	100
4 - 6	2750	0.8	6.3	8.5	4.5	19.2	7.4	7	0.38	0.090	100

Non-insulated receptacles with lateral conductor connector

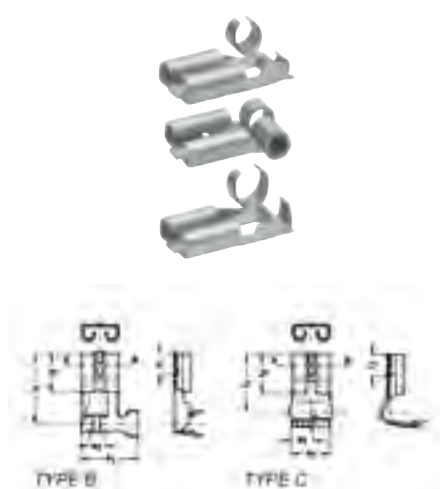

► For fine and superfine stranded conductors, e.g. to DIN EN 60228 Cl. 5 and 6
 ► Improved contact properties due to grooved profile



Material

- Brass (CuZn)



Surface

- Tin-plated to protect against corrosion



Technical instructions

- Tool: see page 176

Nominal cross section mm ²	Part No.	Tab Thickn.	Tab Width	Typ	Dimension mm						Weight/pcs. ~kg	Packing unit/pcs
					a1	a2	l1	l2	l3	l4		
0.5 - 1	3720	0.8	6.3	B	11.0	3.0	12.5	7.4	4.0	7.2	0.080	100
0.5 - 1.5	3725	0.8	6.3	C	7.5	4.0	11.00	7.4	4.0	7.2	0.085	100
1.5 - 2.5	3735	0.8	6.3	B	11.0	3.0	13.5	7.0	4.0	7.2	0.085	100



Non-insulated tabs



- ▶ For fine and superfine stranded conductors, e.g. to DIN EN 60228 Cl. 5 and 6
- ▶ Improved contact properties due to grooved profile



Material

- Brass (CuZn)



Surface

- Tin-plated to protect against corrosion



Technical instructions

- Tool: see page 176

Additional information

- * = dimensions in the plug sector to DIN 46244

Nominal cross section mm ²	Nominal size to DIN	Part No.	Tab Thickn.	Tab Width	Typ	Hint	Dimension mm					Weight/ pcs. ~kg	Packing unit/pcs
							a1	a2	d2	l1	l2		
0.5 - 1		2235	0.8	2.8	A	*	6.0	3.2	1.30	22.5	12.7	0.045	100
	46343 B6.3 - 1	2220	0.8	6.3	A		8.2	4.0	1.65	28.0	16.0	0.085	100
1.5 - 2.5	46248 A6.3 - 2.5	1830	0.8	6.3	B		9.0	4.5	1.65	20.0	8.0	0.065	100
	46343 B6.3 - 2.5	2230	0.8	6.3	A		8.2	4.0	1.65	28.0	16.0	0.090	100
4 - 6	46343 B6.3 - 6	2250	0.8	6.3	A		8.2	4.0	1.65	28.0	16.0	0.100	100

Insulation sleeves



- ▶ For non-insulated tabs
- ▶ Perfectly-matched to the different versions

Characteristics

- For post-insulation of crimped non-insulated receptacles

Material

- PA / PE / PVC

Nominal cross section mm ²	Nominal size to DIN	Part No.	Colour	Typ	Dimension mm			Insulation material	for item	Weight/ pcs. ~kg	Packing unit/pcs
					b1	l	h1				
0.5 - 1	2.8	2755	□	A	6.5	20.0	4.0	PE	18251,18251A, 18201A	0.015	100
0.5 - 1.5	4.8	2760	□	A	7.0	20.0	5.0	PE	18202,18203	0.015	100
1.5 - 2.5		2765	■	A	9.5	20.0	5.5	PE	18302,18303	0.025	100

see next page



Insulation sleeves

Nominal cross section mm ²	Nominal size to DIN	Part No.	Colour	Typ	Dimension mm			Insulation material	for item	Weight/pcs. ~kg	Packing unit/pcs
					b1	l	h1				
0.5 - 2.5	6.3	2770		A	12.5	23.0	8.5	PE	1720,1730	0.035	100
		2775		A	9.5	25.0	5.0	PE	1820,1830	0.030	100
0.5 - 4	6.3	2780		A	9.5	25.0	6.0	PE	1720,1730, 1820,1830	0.030	100
0.5 - 6		2785		B	9.2	24.5	5.6	PA	1720,1730,1750, 2720,2730,2750	0.055	100
	2790		C	13.5	15.0	3.1	PVC	3720,3725, 3735	0.060	100	

Non-insulated tabs, angled version



Characteristics

- To DIN 46342, part 1 and similar versions
- Dimensions in the plug sector to DIN 46244

Material

- Brass (CuZn)

Surface

- Tin-plated to protect against corrosion

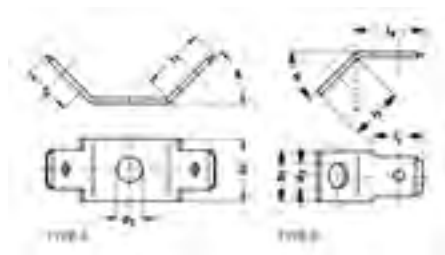

Nominal size to DIN	Part No.	Tab Thickn.	Tab Width	Typ	Dimension mm						Weight/pcs. ~kg	Packing unit/pcs
					b1	d2	l2	l3	l4	w		
--	2040	0.8	2.8	A	5.0	3.2	5.5	6.5	--	60°	0.040	100
	2045	0.8	6.3	A	10.0	4.3	8.0	10.0	--	45°	0.160	100
	2060	0.8	6.3	B	8.0	4.3	8.0	8.0	10.7	30°	0.085	100
	2070	0.8	6.3	B	8.0	3.2	8.0	8.0	10.7	45°	0.085	100
	2075	0.8	6.3	B	8.0	4.1	8.0	8.0	10.7	45°	0.085	100
B 6.3 - 0.8	2080	0.8	6.3	B	8.0	4.3	8.0	8.5	10.7	45°	0.085	100
	2083	0.8	6.3	B	8.0	5.3	8.0	8.5	10.7	45°	0.080	100
--	2090	0.8	6.3	B	8.0	5.3	8.0	8.0	10.7	45°	0.080	100
	2100	0.8	6.3	B	7.5	2.5	8.0	5.7	11.5	90°	0.075	100
	2105	0.8	6.3	B	8.0	3.2	8.0	8.0	11.5	90°	0.085	100
C 6.3 - 0.8	2115	0.8	6.3	B	8.0	4.3	8.0	8.5	11.5	90°	0.090	100



Non-insulated tabs, straight version

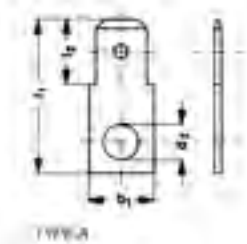

Characteristics

- To DIN 46342, part 1 and similar versions
- Dimensions in the plug sector to DIN 46244

Material

- Brass (CuZn)

Surface

- Tin-plated to protect against corrosion

Nominal size to DIN	Part No.	Tab Thickn.	Tab Width	Typ	Dimension mm					Weight/pcs. ~kg	Packing unit/pcs
					b1	d2	l1	l2	s		
--	2123	0.8	2.8	A	4.5	3.1	13.0	5.5	0.8	0.028	100
A 6.3 - 0.8	2140	0.8	6.3	A	8.0	4.3	19.0	8.0	0.8	0.086	100
--	2145	0.8	6.3	A	8.0	5.3	19.0	8.0	0.8	0.080	100

Non-insulated tabs for soldering

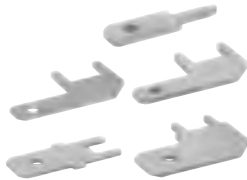

► Material used offers very good soldering characteristics

Characteristics

- Dimensions in the plug sector to DIN 46244
- For soldering in printed circuits

Material

- Brass (CuZn)

Surface

- Tin-plated to protect against corrosion

Part No.	Tab Thickn.	Tab Width	Typ	Dimension mm								Weight/pcs. ~kg	Packing unit/pcs
				b1	b2	b3	l1	l2	l3	l4	s		
2010	0.8	2.8	A	--	--	--	10.5	6.5	--	--	0.8	0.015	100
2020	0.5	2.8	C	1.0	5	--	--	7.1	8	13.4	0.5	0.025	100
2025	0.8	2.8	C	1.0	5	--	--	7.1	8	13.4	0.8	0.040	100
2030	0.8	6.3	D	3.5	5	6.4	16.0	8.0	4	12.0	0.8	0.065	100
2035	0.8	6.3	E	3.8	5	6.2	16.0	8.0	3	12.0	0.8	0.085	100



Non-insulated multiple tabs

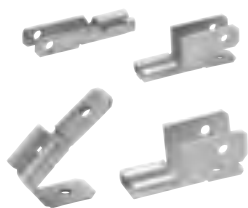

Characteristics

- Dimensions in the plug sector to DIN 46244

Material

- Brass (CuZn)

Surface

- Tin-plated to protect against corrosion



Part No.	Tab Thickn.	Tab Width	Typ	Dimension mm									Weight/ pcs. ~kg	Packing unit/pcs
				a1	b2	b3	l1	l2	l3	h	w	s		
735	0.8	2.8	A	5	3.2	3.1	16.0	6.7	--	--	--	0.38	0.060	100
755	0.8	4.8	C	--	4.4	--	20.0	7.0	7.0	8.0	--	0.38	0.155	100
725	0.8	6.3	D	--	--	--	--	8	7.5	--	15°	0.38	0.115	100
775	0.8	6.3	C	--	--	--	20.5	12	7.5	9.6	--	0.38	0.200	100

Flexible connector, tab width 2.8 mm, 4.8 mm and 6.3 mm

▶ No additional insulation required



Characteristics

- With tabs 2.8, 4.8 or 6.3 x 0.8 mm
- 1, 2 and 12-poles
- Further poles on request

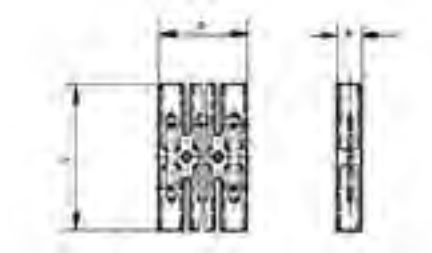

Part No.	Tab Thickn.	Tab Width	Poles	Dimension mm				Insulation material	Bolt size mm		Weight/ pcs. ~kg	Packing unit/pcs
				b	l	h	s		Distance	Diameter		
Tab Width 2.8 mm												
8101	0.8	2.8	1	7.5	35	5.5	0.8	PVC	--	--	0.2	100
8102	0.8	2.8	2	15.0	35	5.5	0.8	PVC	--	2.7	0.3	50
81012	0.8	2.8	12	88.0	35	5.5	0.8	PVC	75	2.7	1.6	10
Tab Width 4.8 mm												
8051	0.8	4.8	1	12.5	28	6.6	0.8	PVC	--	--	0.25	100
8052	0.8	4.8	2	25.0	28	6.6	0.8	PVC	--	3.2	0.50	50
80512	0.8	4.8	12	142.0	28	6.6	0.8	PVC	120	3.2	2.80	10
Tab Width 6.3 mm												
8001	0.8	6.3	1	12.5	28	6.6	0.8	PVC	--	--	0.30	100
8002	0.8	6.3	2	25.0	28	6.6	0.8	PVC	--	3.7	0.55	50
80012	0.8	6.3	12	142.0	28	6.6	0.8	PVC	120	3.7	3.20	10



Polyamide connector, tab width 2.8 and 6.3 mm

► No additional insulation required



Characteristics

- With tabs 2.8 x 0.8 mm and 6.3 x 0.8 mm
- 1, 2 and 12-poles
- Further poles on request

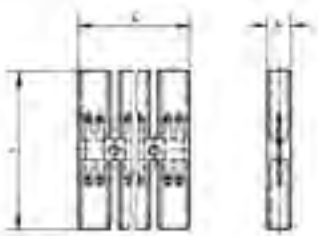

Part No.	Tab Thickn.	Tab Width	Poles	Dimension mm				Insulation material	Bolt size mm		Weight/ pcs. ~kg	Packing unit/pcs
				b	l	h	s		Distance	Diameter		
8011	0.8	6.3 and 2 x 2.8	1	10.0	50	7.5	0.8	PA	--	--	0.25	100
8012	0.8	6.3 and 2 x 2.8	2	22.5	50	7.5	0.8	PA	--	3.1	0.50	50
80112	0.8	6.3 and 2 x 2.8	12	147.5	50	7.5	0.8	PA	125	3.1	3.10	10

Flexible circuit distributor, tab width 2.8 mm

► No additional insulation required



Characteristics

- With tabs 2.8 x 0.8 mm
- 1 and 12-poles
- Further poles on request

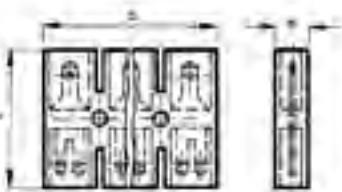

Part No.	Tab Thickn.	Tab Width	Poles	Dimension mm				Insulation material	Bolt size mm		Weight/ pcs. ~kg	Packing unit/pcs
				b	l	h	s		Distance	Diameter		
8151	0.8	2.8	1	12.5	28	7	0.8	PVC	--	--	0.25	100
81512	0.8	2.8	12	147.0	28	7	0.8	PVC	123	3.2	2.80	10



Flexible circuit distributor, tab width 6.3 mm



▶ No additional insulation required

Characteristics

- With tabs 6.3 x 0.8 mm

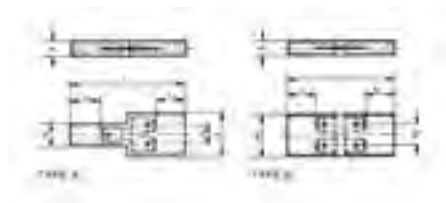

Part No.	Tab Thickn.	Tab Width	Typ	Dimension mm								Insulation material	Weight/ pcs. ~kg	Packing unit/pcs
				b	b1	b2	l	l1	h	s				
816	0.8	6.3	A	21	11.3	9	53	15	7.5	0.8	PVC	0.60	10	
817	0.8	6.3	B	20	11.3	9	51	13	7.0	0.8	PVC	0.65	10	

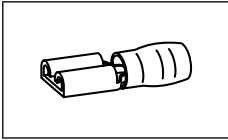

Tool application chart

Insulated cable connections

Tool type	Crimping range corresponds to nominal cross-section mm ²	Crimping Tool		Catalogue page		Crimp profile
		Part No.	Crimping head / adapter	Crimping Tool	Crimping die	
Mechanical crimping tools	0.1-1	K80		221		○
	0.5-2.5	K81		222		○
	0.5-6	K82		222		○
Mechanical, electrical, pneumatic crimping tools with interchangeable die / head	0.1-1	KP1	+KP80	240		○
		KP1L	+KP80	240		○
	0.5-2.5	KP1	+KP81	240		○
		KP1L	+KP81	240		○
	0.5-6	K50		244	327	○
		EK50ML		254	327	○
	4-6	KP1	+KP83	240		○
		KP1L	+KP83	240		○
Battery powered crimping tools	0.1-1	EKP1ML	+KP80	260		○
	0.5-2.5	EKP1ML	+KP81	260		○
	0.5-6	EK1550ML		258	327	○
	4-6	EKP1ML	+KP83	260		○

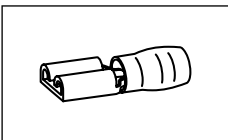

Tool application chart

Butt connectors with heat shrink insulation

Tool type	Crimping range corresponds to nominal cross-section mm ²	Crimping Tool		Catalogue page		Crimp profile
		Part No.	Crimping head / adapter	Crimping Tool	Crimping die	
Mechanical, electrical, pneumatic crimping tools with interchangeable die / head	0.5-6	K50		244	327	○
		EK50ML		254	327	○
Battery powered crimping tools	0.5-6	EK1550ML		258	327	○

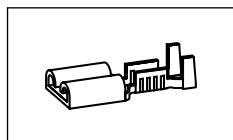

Tool application chart

Non-insulated receptacles, straight type

Tool type	Crimping range corresponds to nominal cross-section mm ²	Crimping Tool		Catalogue page		Crimp profile
		Part No.	Crimping head / adapter	Crimping Tool	Crimping die	
Mechanical crimping tools	0.1-1	K572		224		☺
		K67		225		☺
	0.5-2.5	K582		224		☺
		K65		226		☺
	0.5-6	K592		225		☺
		K60		223		☺
Mechanical, electrical, pneumatic crimping tools with interchangeable die / head	0.25-6	K50		244	327	☺
		EK50ML		254	327	☺
Battery powered crimping tools	0.25-6	EK1550ML		258	327	☺

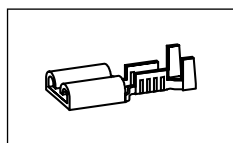

Tool application chart

Non-insulated receptacles, with lateral conductor connector

Tool type	Crimping range corresponds to nominal cross-section mm ²	Crimping Tool		Catalogue page		Crimp profile
		Part No.	Crimping head / adapter	Crimping Tool	Crimping die	
Mechanical crimping tools	3720, 3735	K63		226		☺
	3725	K64		227		☺
Mechanical, electrical, pneumatic crimping tools with interchangeable die / head	3720, 3735	K50		244	327	☺
		EK50ML		254	327	☺
		SKP6		242		☺
	3725	K50		244	327	☺
		EK50ML		254	327	☺
		SKP6		242		☺
Battery powered crimping tools	3720, 3735	EK1550ML		258	327	☺
	3725	EK1550ML		258	327	☺





PRACTICAL - POCKET BOXES AND ASSORTMENT BOXES

A good professional is always well sorted. The most important thing is the availability of tool and connector material. In Klauke assortment boxes from robust metal, the tools are supplied with matching cable lugs and connectors. Everything matches. Materials and tools have their own space - clearly arranged and immediately to hand. The boxes equip you for every application. On request, we can also stock them to suit your individual needs.



In brief

- ▶ Brings order to the workplace due to clearly arranged design
- ▶ Everything to hand in one box
- ▶ Stocked to suit your needs and numerous versions available



► **Practical and always to hand**

With the practical pocket boxes, everything has its place and is always to hand, on the go and in the workshop. Chute openings for stackable pocket boxes simplify the removal of cable end-sleeves.

- Cable-end sleeves with and without insulation always to hand
- Practical chute opening for easy removal
- Stackable box
- Tough and impact-proof plastic



► **Our range, your order**

We have already compiled an assortment for you. We offer pre-filled boxes for various applications. You can also fill the robust box yourself if you want.

- High-quality boxes made from plastic or metal
- Contains tool and connectors matched to one other
- Even if exposed to severe vibrations or dropped, everything remains in the right compartment
- Boxes also available empty or custom-filled



ST 23 B Pocket box with cable end-sleeves 0.25 - 1 mm²



► Pocket box made from impact-resistant plastic

Characteristics

- Stackable and resealable

Item			Part No.
Pocket box with cable end-sleeves 0.25 - 1 mm ² to DIN 46228 part 1			ST23B
Scope of supply	Description	Quantity	Page
ST23L	Pocket box	1	
695V	Cable end-sleeve, 0.25 mm ² , 5 mm	1000	138
705V	Cable end-sleeve, 0.34 mm ² , 5 mm, Cu tinned	1000	138
716V	Cable end-sleeve, 0.75 mm ² , 6 mm	1000	138
71S6V	Cable end-sleeve, 0.5 mm ² , 6 mm, Cu tinned	500	138
72S6V	Cable end-sleeve, 1.0 mm ² , 6 mm	500	138

ST 21 B Pocket box with cable end-sleeves 0.5 - 2.5 mm²



► Pocket box made from impact-resistant plastic

Characteristics

- Stackable and resealable

Item			Part No.
Pocket box with cable end-sleeves 0.5 - 2.5 mm ² to DIN 46228 part 1			ST21B
Scope of supply	Description	Quantity	Page
ST21L	Pocket box	1	
71S6V	Cable end-sleeve, 0.5 mm ² , 6 mm, Cu tinned	1000	138
716V	Cable end-sleeve, 0.75 mm ² , 6 mm	500	138
72S6V	Cable end-sleeve, 1.0 mm ² , 6 mm	500	138
727V	Cable end-sleeve, 1.5 mm ² , 7 mm	500	138
737V	Cable end-sleeve, 2.5 mm ² , 7 mm	500	138

ST 22 B Pocket box with cable end-sleeves 4 - 16 mm²



► Pocket box made from impact-resistant plastic

Characteristics

- Stackable and resealable

Item			Part No.
Pocket box with cable end-sleeves 4 - 16 mm ² to DIN 46228 part 1			ST22B
Scope of supply	Description	Quantity	Page
ST22L	Pocket box	1	
749V	Cable end-sleeve, 4 mm ² , 9 mm	200	139
7512V	Cable end-sleeve, 6 mm ² , 12 mm, Cu tinned	100	139
7612V	Cable end-sleeve, 10 mm ² , 12 mm, Cu tinned	70	139
7712V	Cable end-sleeve, 16 mm ² , 12 mm, Cu tinned	70	139



ST 15 B Pocket box with insulated twin cable end-sleeves 2 x 0.75 - 2 x 2.5 mm²



► Pocket box made from impact-resistant plastic

Characteristics

- Stackable and resealable

Item				Part No.	
Pocket box with twin cable end-sleeves 2 x 0.75 - 2 x 2.5 mm ²				ST15B	
Scope of supply	Colour	Description	Quantity	Page	
ST15L		Pocket box	1		
8708		Insl. twin cable end-sleeve, 2 x 0.75 mm ²	50	147	
8718		Insl. twin cable end-sleeve, 2 x 1 mm ²	50	147	
8728		Insl. twin cable end-sleeve, 2 x 1.5 mm ²	50	147	
87310		Insl. twin cable end-sleeve, 2 x 2.5 mm ²	50	147	

ST 1 B pocket box with insl. cable end-sleeves 0.5 - 2.5 mm², DIN 46228 Part 4



► Pocket box made from impact-resistant plastic

Characteristics

- Stackable and resealable

Item				Part No.	
Pocket box with insl. cable end-sleeves 0.5 - 2.5 mm ² , DIN 46228 Part 4, colour code 1				ST1B	
Scope of supply	Colour	Description	Quantity	Page	
ST1L		Pocket box	1		
1690		Insl. cable end-sleeve, 0.5 mm ² , 14 mm	50	142	
170W		Insl. cable end-sleeve, 0.75 mm ² , 14.6 mm	100	143	
171G		Insl. cable end-sleeve, 1 mm ² , 14.6 mm	100	143	
172RO		Insl. cable end-sleeve, 1.5 mm ² , 14.6 mm	100	143	
173B		Insl. cable end-sleeve, 2.5 mm ² , 15.2 mm	50	143	

ST 11 B pocket box with insl. cable end-sleeves 0.5 - 2.5 mm², DIN 46228 Part 4



► Pocket box made from impact-resistant plastic

Characteristics

- Stackable and resealable

Item				Part No.	
Pocket box with insl. cable end-sleeves 0.5 - 2.5 mm ² , DIN 46228 Part 4				ST11B	
Scope of supply	Colour	Description	Quantity	Page	
ST11L		Pocket box	1		
4698		Insl. Cable end-sleeve, 0.5 mm ² , 14 mm	50	141	
4708		Insl. cable end-sleeve, 0.75 mm ² , 14 mm	100	141	
4718		Insl. cable end-sleeve, 1 mm ² , 14 mm	100	141	
4728		Insl. cable end-sleeve, 1.5 mm ² , 14 mm	100	141	
4738		Insl. cable end-sleeve, 2.5 mm ² , 14 mm	50	141	

ST 31 B pocket box with insl. cable end-sleeves 0.5 - 2.5 mm², DIN 46228 Part 4, colour code 2



► Pocket box made from impact-resistant plastic

Characteristics

- Stackable and resealable

Item				Part No.
Pocket box with insl. cable end-sleeves 0.5 - 2.5 mm ² , DIN 46228 Part 4, colour code 2				ST31B
Scope of supply	Colour	Description	Quantity	Page
ST31L		Pocket box	1	
1698		Insl. cable end-sleeve, 0.5 mm ² , 13 mm	50	144
1708		Insl. cable end-sleeve, 0.75 mm ² , 13.5 mm	100	144
1718		Insl. cable end-sleeve, 1 mm ² , 13.5 mm	100	144
1728		Insl. cable end-sleeve, 1.5 mm ² , 13.5 mm	100	144
1738		Insl. cable end-sleeve, 2.5 mm ² , 14.5 mm	50	144

ST 12 B pocket box with insl. cable end-sleeves 4 - 16 mm², DIN 46228 Part 4



► Pocket box made from impact-resistant plastic

Characteristics

- Stackable and resealable

Item				Part No.
Pocket box with insl. cable end-sleeves 4 - 16 mm ² , DIN 46228 Part 4				ST12B
Scope of supply	Colour	Description	Quantity	Page
ST12L		Pocket box	1	
47410		Insl. cable end-sleeve, 4 mm ² , 17 mm	50	141
47512		Insl. cable end-sleeve, 6 mm ² , 20 mm	20	141
47612		Insl. cable end-sleeve, 10 mm ² , 22 mm	20	141
47712		Insl. cable end-sleeve, 16 mm ² , 24 mm	10	142

ST 2 B pocket box with insl. cable end-sleeves 4 - 16 mm², DIN 46228 Part 4, colour code 1



► Pocket box made from impact-resistant plastic

Characteristics

- Stackable and resealable

Item				Part No.
Pocket box with insl. cable end-sleeves 4 - 16 mm ² , DIN 46228 Part 4, colour code 1				ST2B
Scope of supply	Colour	Description	Quantity	Page
ST2L		Pocket box	1	
174GR		Insl. cable end-sleeve, 4 mm ² , 16.5 mm	50	143
175S		Insl. cable end-sleeve, 6 mm ² , 20 mm	20	143
176E		Insl. cable end-sleeve, 10 mm ² , 21.5 mm	20	143
177GR		Insl. cable end-sleeve, 16 mm ² , 22.2 mm	10	143



ST 32 B pocket box with insl. cable end-sleeves 4 - 16 mm², DIN 46228 Part 4, colour code 2



▶ Pocket box made from impact-resistant plastic

Characteristics

- Stackable and resealable

Item				Part No.
Pocket box with insl. cable end-sleeves 4 - 16 mm ² , DIN 46228 Part 4, colour code 2				ST32B
Scope of supply	Colour	Description	Quantity	Page
ST32L		Pocket box	1	
17410		Insl. cable end-sleeve, 4 mm ² , 16.5 mm	50	144
17512		Insl. cable end-sleeve, 6 mm ² , 20 mm	20	144
17612		Insl. cable end-sleeve, 10 mm ² , 21.5 mm	20	145
17712		Insl. cable end-sleeve, 16 mm ² , 23.5 mm	10	145

ST 3 B pocket box with insl. cable end-sleeves 0.25 - 1 mm², DIN 46228 Part 4, colour code 1



▶ Pocket box made from impact-resistant plastic

Characteristics

- Stackable and resealable

Item				Part No.
Pocket box with insl. cable end-sleeves 0.25 - 1 mm ² , DIN 46228 Part 4, colour code 1				ST3B
Scope of supply	Colour	Description	Quantity	Page
ST3L		Pocket box	1	
167H		Insl. cable end-sleeve, 0.25 mm ² , 10.4 mm	30	142
168T		Insl. cable end-sleeve, 0.34 mm ² , 10.4 mm	30	142
1690		Insl. cable end-sleeve, 0.5 mm ² , 14 mm	30	142
170W		Insl. cable end-sleeve, 0.75 mm ² , 14.6 mm	30	143
171G		Insl. cable end-sleeve, 1 mm ² , 14.6 mm	30	143

ST 13 B pocket box with insl. cable end-sleeves 0.25 - 1 mm², DIN 46228 Part 4 & similar, colour code 1



▶ Pocket box made from impact-resistant plastic

Characteristics

- Stackable and resealable

Item				Part No.
Pocket box with insl. cable end-sleeves 0.25 - 1 mm ² , DIN 46228 Part 4 & similar, colour code 1				ST13B
Scope of supply	Colour	Description	Quantity	Page
ST13L		Pocket box	1	
167H		Insl. cable end-sleeve, 0.25 mm ² , 10.4 mm	30	142
168T		Insl. cable end-sleeve, 0.34 mm ² , 10.4 mm	30	142
4698		Insl. Cable end-sleeve, 0.5 mm ² , 14 mm	30	141
4708		Insl. cable end-sleeve, 0.75 mm ² , 14 mm	30	141
4718		Insl. cable end-sleeve, 1 mm ² , 14 mm	30	141





**ST 33 B pocket box with insl. cable end-sleeves 0.25-1 mm²,
DIN 46228 Part 4 & similar, colour code 2**



► Pocket box made from impact-resistant plastic

Characteristics

- Stackable and resealable

Item				Part No.
Pocket box with insl. cable end-sleeves 0.25 - 1 mm ² , DIN 46228 Part 4 & similar, colour code 2				ST33B
Scope of supply	Colour	Description	Quantity	Page
ST33L		Pocket box	1	
1676		Insl. cable end-sleeve, 0.25 mm ² , 11 mm	30	144
1686		Insl. cable end-sleeve, 0.34 mm ² , 11 mm	30	144
1698		Insl. cable end-sleeve, 0.5 mm ² , 13 mm	30	144
1708		Insl. cable end-sleeve, 0.75 mm ² , 13.5 mm	30	144
1718		Insl. cable end-sleeve, 1 mm ² , 13.5 mm	30	144

GR 4698 DO Pocket box with insulated cable end-sleeves 0.5 mm²



► Pocket box made from impact-resistant plastic

Characteristics

- Stackable and resealable

Item				Part No.
Pocket box with insulated cable end-sleeves 0.5 mm ² to DIN 46228 part 4				GR4698DO
Scope of supply	Colour	Description	Quantity	Page
4698		Insl. Cable end-sleeve, 0.5 mm ² , 14 mm	1000	141

GR 4708 DO Pocket box with insulated cable end-sleeves 0.75 mm²



► Pocket box made from impact-resistant plastic

Characteristics

- Stackable and resealable

Item				Part No.
Pocket box with insulated cable end-sleeves 0.75 mm ² DIN 46228 part 4				GR4708DO
Scope of supply	Colour	Description	Quantity	Page
4708		Insl. cable end-sleeve, 0.75 mm ² , 14 mm	1000	141

GR 4718 DO Pocket box with insulated cable end-sleeves 1 mm²



► Pocket box made from impact-resistant plastic

Characteristics

- Stackable and resealable

Item				Part No.
Pocket box with insulated cable end-sleeves 1 mm ² DIN 46228 part 4				GR4718DO
Scope of supply	Colour	Description	Quantity	Page
4718		Insl. cable end-sleeve, 1 mm ² , 14 mm	1000	141



GR 4728 DO Pocket box with insulated cable end-sleeves 1.5 mm²



▶ Pocket box made from impact-resistant plastic

Characteristics

- Stackable and resealable

Item				Part No.	
Pocket box with insulated cable end-sleeves 1.5 mm ² DIN 46228 part 4				GR4728DO	
Scope of supply	Colour	Description	Quantity	Page	
4728	■	Insl. cable end-sleeve, 1.5 mm ² , 14 mm	1000	141	

GR 4738 DO Pocket box with insulated cable end-sleeves 2.5 mm²



▶ Pocket box made from impact-resistant plastic

Characteristics

- Stackable and resealable

Item				Part No.	
Pocket box with insulated cable end-sleeves 2.5 mm ² DIN 46228 part 4				GR4738DO	
Scope of supply	Colour	Description	Quantity	Page	
4738	■	Insl. cable end-sleeve, 2.5 mm ² , 14 mm	1000	141	

ST 5 L assortment of empty pocket boxes



▶ Pocket box made from impact-resistant plastic

Characteristics

- Stackable and resealable

Item		Part No.	
Assortment of pocket boxes		ST5L	

SK 30 B Steel assortment box with cable end-sleeves and crimping tool



▶ Hammer-tone finished assortment box
▶ Ideal for workshop equipment

Item		Dimension mm	Part No.	
Steel assortment box with cable end-sleeves and crimping tool		200 x 140 x 40	SK30B	
Scope of supply	Description	Quantity	Page	
SK30L	Steel carrying case	1	193	
K48	Crimping tool for cable end-sleeves 0.14 - 2.5 mm ²	1	212	
716V	Cable end-sleeve, 0.75 mm ² , 6 mm	1000	138	
72S6V	Cable end-sleeve, 1.0 mm ² , 6 mm	1000	138	
727V	Cable end-sleeve, 1.5 mm ² , 7 mm	1000	138	
737V	Cable end-sleeve, 2.5 mm ² , 7 mm	1000	138	

SK 32 B Steel assortment box with cable end-sleeves and crimping tool



- ▶ Broad cable end-sleeve assortment appropriate crimping tool
- ▶ Hammer-tone finished assortment box
- ▶ Ideal for workshop equipment

Item	Dimension mm	Part No.
Steel assortment box with cable end-sleeves and crimping tool	285 x 155 x 45	SK32B

Scope of supply	Description	Quantity	Page
SK32L	Steel carrying case	1	193
K3	Crimping tool for cable end-sleeves 0.5 - 16 mm ²	1	211
716V	Cable end-sleeve, 0.75 mm ² , 6 mm	1000	138
72S6V	Cable end-sleeve, 1.0 mm ² , 6 mm	1000	138
727V	Cable end-sleeve, 1.5 mm ² , 7 mm	1000	138
737V	Cable end-sleeve, 2.5 mm ² , 7 mm	500	138
749V	Cable end-sleeve, 4 mm ² , 9 mm	500	139
7510V	Cable end-sleeve, 6 mm ² , 10 mm	500	139
7618V	Cable end-sleeve, 10 mm ² , 18 mm	250	139
7718V	Cable end-sleeve, 16 mm ² , 18 mm	150	139

SK 45 B Steel assortment box with insl. cable end-sleeves and crimping tool



- ▶ Four of the most important insulated cable end-sleeve types in a steel carrying case including an appropriate crimping tool
- ▶ Hammer-tone finished assortment box
- ▶ Ideal for workshop equipment

Item	Dimension mm	Part No.
Steel assortment box with insl. cable end-sleeves and crimping tool	200 x 140 x 40	SK45B

Scope of supply	Colour	Description	Quantity	Page
SK30L		Steel carrying case	1	193
K48		Crimping tool for cable end-sleeves 0.14 - 2.5 mm ²	1	212
4708	■	Insl. cable end-sleeve, 0.75 mm ² , 14 mm	300	141
4718	■	Insl. cable end-sleeve, 1 mm ² , 14 mm	300	141
4728	■	Insl. cable end-sleeve, 1.5 mm ² , 14 mm	300	141
4738	■	Insl. cable end-sleeve, 2.5 mm ² , 14 mm	200	141



SK 47 B Steel assortment box with insl. cable end-sleeves and crimping tool



- ▶ Flexible use due to large cross-sectional range
- ▶ Hammer-tone finished assortment box
- ▶ Ideal for workshop equipment

Item	Dimension mm	Part No.
Steel assortment box with insl. cable end-sleeves and crimping tool	285 x 155 x 45	SK47B

Scope of supply	Colour	Description	Quantity	Page
SK32L		Steel carrying case	1	193
K3		Crimping tool for cable end-sleeves 0.5 - 16 mm ²	1	211
4708	■	Insl. cable end-sleeve, 0.75 mm ² , 14 mm	200	141
4718	■	Insl. cable end-sleeve, 1 mm ² , 14 mm	200	141
4728	■	Insl. cable end-sleeve, 1.5 mm ² , 14 mm	200	141
4738	■	Insl. cable end-sleeve, 2.5 mm ² , 14 mm	200	141
47410	■	Insl. cable end-sleeve, 4 mm ² , 17 mm	100	141
47512	■	Insl. cable end-sleeve, 6 mm ² , 20 mm	100	141
47618	■	Insl. cable end-sleeve, 10 mm ² , 28 mm	100	141
47718	■	Insl. cable end-sleeve, 16 mm ² , 28 mm	50	142

SK 30/3 P Assortment box from plastic with insl. cable end-sleeves and tools



- ▶ With everything needed for conductor preparation
- ▶ The exact-shaped foam inlays of the case prevent the contents slipping even with severe impacts

Item	Dimension mm	Part No.
Plastic assortment box with insl. cable end-sleeves and tools	395 x 295 x 106	SK303P

Scope of supply	Colour	Description	Quantity	Page
K432		Automatic wire stripper K43/2 0.02 - 10 mm ²	1	545
K303		Crimping tool for cable end-sleeves and twin cable end-sleeves 0.08 - 10 mm ²	1	217
4698	□	Insl. Cable end-sleeve, 0.5 mm ² , 14 mm	400	141
4708	■	Insl. cable end-sleeve, 0.75 mm ² , 14 mm	400	141
4718	■	Insl. cable end-sleeve, 1 mm ² , 14 mm	400	141
4728	■	Insl. cable end-sleeve, 1.5 mm ² , 14 mm	400	141
4738	■	Insl. cable end-sleeve, 2.5 mm ² , 14 mm	200	141
47410	■	Insl. cable end-sleeve, 4 mm ² , 17 mm	200	141
47512	■	Insl. cable end-sleeve, 6 mm ² , 20 mm	100	141
47612	■	Insl. cable end-sleeve, 10 mm ² , 22 mm	100	141

SK 30/3 S Assortment box from plastic with insl. cable end-sleeves and crimping tool



- ▶ With everything needed for conductor preparation
- ▶ The exact-shaped foam inlays of the case prevent the contents slipping even with severe impacts

Item	Dimension mm	Part No.
Plastic assortment box with insl. cable end-sleeves and crimping tool	275 x 230 x 83	SK303S

Scope of supply	Colour	Description	Quantity	Page
K303		Crimping tool for cable end-sleeves and twin cable end-sleeves 0.08 - 10 mm ²	1	217
4698	□	Insl. Cable end-sleeve, 0.5 mm ² , 14 mm	100	141
4708	■	Insl. cable end-sleeve, 0.75 mm ² , 14 mm	100	141
4718	■	Insl. cable end-sleeve, 1 mm ² , 14 mm	100	141
4728	■	Insl. cable end-sleeve, 1.5 mm ² , 14 mm	100	141
4738	■	Insl. cable end-sleeve, 2.5 mm ² , 14 mm	50	141
47410	■	Insl. cable end-sleeve, 4 mm ² , 17 mm	50	141
47512	■	Insl. cable end-sleeve, 6 mm ² , 20 mm	30	141
47612	■	Insl. cable end-sleeve, 10 mm ² , 22 mm	30	141

SK 43 NB Assortment box from plastic with insl. cable end-sleeves and tools



- ▶ With everything needed for conductor preparation
- ▶ Ideal for workshop equipment

Item	Dimension mm	Part No.
Steel assortment box with insl. cable end-sleeves and tools	370 x 210 x 40	SK43NB

Scope of supply	Colour	Description	Quantity	Page
SK43L		Steel carrying case	1	193
K432		Automatic wire stripper K43/2 0.02 - 10 mm ²	1	545
K303		Crimping tool for cable end-sleeves and twin cable end-sleeves 0.08 - 10 mm ²	1	217
4698	□	Insl. Cable end-sleeve, 0.5 mm ² , 14 mm	500	141
4708	■	Insl. cable end-sleeve, 0.75 mm ² , 14 mm	500	141
4718	■	Insl. cable end-sleeve, 1 mm ² , 14 mm	400	141
4728	■	Insl. cable end-sleeve, 1.5 mm ² , 14 mm	400	141
4738	■	Insl. cable end-sleeve, 2.5 mm ² , 14 mm	300	141
47410	■	Insl. cable end-sleeve, 4 mm ² , 17 mm	100	141
47512	■	Insl. cable end-sleeve, 6 mm ² , 20 mm	100	141
47612	■	Insl. cable end-sleeve, 10 mm ² , 22 mm	100	141



SK 65 B Assortment box from steel with tubular cable lugs and crimping tool

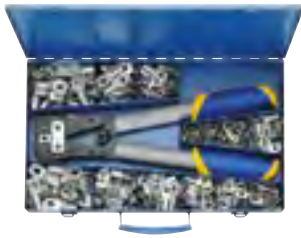

- ▶ Hammer-tone finished assortment box
- ▶ Ideal for workshop equipment

Characteristics

- Sturdy steel carrying case with lock and handle

Item	Dimension mm	Part No.	
Steel assortment box with tubular cable lugs "standard type" and crimping tool K05	400 x 250 x 50	SK65B	
Scope of supply	Description	Quantity	Page
SK65L	Steel carrying case	1	195
K05	Crimping tool for tubular cable lugs and connectors, standard type 6 - 50 mm ²	1	235
1R6	Tubular cable lug without inspection hole, 6 mm ² , M6, Cu tinned	25	14
1R8	Tubular cable lug without inspection hole, 6 mm ² , M8, Cu tinned	25	14
2R6	Tubular cable lug without inspection hole, 10 mm ² , M6, Cu tinned	25	14
2R8	Tubular cable lug without inspection hole, 10 mm ² , M8, Cu tinned	25	14
3R8	Tubular cable lug without inspection hole, 16 mm ² , M8, Cu tinned	25	14
3R10	Tubular cable lug without inspection hole, 16 mm ² , M10, Cu tinned	25	14
4R8	Tubular cable lug without inspection hole, 25 mm ² , M8, Cu tinned	25	14
4R10	Tubular cable lug without inspection hole, 25 mm ² , M10, Cu tinned	25	14
5R8	Tubular cable lug without inspection hole, 35 mm ² , M8, Cu tinned	20	14
5R10	Tubular cable lug without inspection hole, 35 mm ² , M10, Cu tinned	20	14
6R10	Tubular cable lug without inspection hole, 50 mm ² , M10, Cu tinned	20	15
6R12	Tubular cable lug without inspection hole, 50 mm ² , M12, Cu tinned	20	15

SK 50 B Steel assortment box with DIN compressed cable lugs and crimping tool



- ▶ Hammer-tone finished assortment box
- ▶ Ideal for workshop equipment

Characteristics

- Sturdy steel carrying case with lock and handle

Item	Dimension mm	Part No.	
Steel assortment box with DIN compression cable lugs and crimping tool	400 x 250 x 50	SK50B	
Scope of supply	Description	Quantity	Page
SK65L	Steel carrying case	1	195
K05D	Crimping tool for compression cable lugs and connectors (DIN 46235 / DIN 46267, Part 1) 6 - 50 mm ²	1	235
101R5	Compression cable lug, DIN 46235, 6 mm ² , M5, Cu tinned	50	56
101R6	Compression cable lug, DIN 46235, 6 mm ² , M6, Cu tinned	50	56
102R5	Compression cable lug, DIN 46235, 10 mm ² , M5, Cu tinned	50	56
102R6	Compression cable lug, DIN 46235, 10 mm ² , M6, Cu tinned	50	56
103R8	Compression cable lug, DIN 46235, 16 mm ² , M8, Cu tinned	25	56
103R10	Compression cable lug, DIN 46235, 16 mm ² , M10, Cu tinned	25	56
104R8	Compression cable lug, DIN 46235, 25 mm ² , M8, Cu tinned	25	56
104R10	Compression cable lug, DIN 46235, 25 mm ² , M10, Cu tinned	25	56
105R8	Compression cable lug, DIN 46235, 35 mm ² , M8, Cu tinned	20	56
105R10	Compression cable lug, DIN 46235, 35 mm ² , M10, Cu tinned	20	56
106R10	Compression cable lug, DIN 46235, 50 mm ² , M10, Cu tinned	15	57
106R12	Compression cable lug, DIN 46235, 50 mm ² , M12, Cu tinned	15	57



MK 230 B 507 Steel assortment box with insl. cable connections and crimping tool



- ▶ Hammer-tone finished assortment box
- ▶ Ideal for workshop equipment

Item	Dimension mm	Part No.
Steel assortment box with insl. cable connections and crimping tool	366 x 230 x 51	MK230B507

Scope of supply	Colour	Description	Quantity	Page
MK230L		Steel carrying case	1	194
K507		Crimping tool with replaceable dies	1	243
6204	■	Insl. solderless terminal M4, 0.5 - 1 mm ²	50	156
6205	■	Insl. solderless terminal M5, 0.5 - 1 mm ²	50	156
6206	■	Insl. solderless terminal M6, 0.5 - 1 mm ²	50	156
6304	■	Insl. solderless terminal M4, 1.5 - 2.5 mm ²	50	156
6305	■	Insl. solderless terminal M5, 1.5 - 2.5 mm ²	50	156
6306	■	Insl. solderless terminal M6, 1.5 - 2.5 mm ²	50	156
670	■	Insl. butt connector, 0.5 - 1 mm ²	50	165
680	■	Insl. butt connector, 1.5 - 2.5 mm ²	50	165
705	■	Insl. pin terminal, 0.5 - 1 mm ² , 22 mm	50	158
710	■	Insl. pin terminal, 1.5 - 2.5 mm ² , 23 mm	50	158
730	■	Insl. receptacle 6.3 x 0.8 mm, 1.5 - 2.5 mm ²	50	161
830	■	Insl. tab 6.3 x 0.8 mm, 1.5 - 2.5 mm ²	50	164
620C4	■	Insl. solderless terminal M4, 0.5 - 1 mm ²	50	157
630C4	■	Insl. solderless terminal M4, 1.5 - 2.5 mm ²	50	157
715	■	Insl. pin terminal, 0.1 - 0.4 mm ² , 26 mm	25	158
700	■	Insl. butt connector, 4 - 6 mm ²	25	165
6505	■	Insl. solderless terminal M5, 4 - 6 mm ²	25	156
6506	■	Insl. solderless terminal M6, 4 - 6 mm ²	25	156
650C6	■	Insl. solderless terminal M6, 4 - 6 mm ²	25	157

SK 82 P Assortment box from plastic with insl. cable connections and tools



- ▶ With everything needed for conductor preparation
- ▶ The exact-shaped foam inlays of the case prevent the contents slipping even with severe impacts

Item	Dimension mm	Part No.		
Plastic assortment box with insl. cable connections and tools	395 x 295 x 106	SK82P		
Scope of supply	Colour	Description	Quantity	Page
K432		Automatic wire stripper K43/2 0.02 - 10 mm ²	1	545
K82A		Crimping tool for insulated cable connections 0.5 - 6 mm ²	1	222
6204	■	Insl. solderless terminal M4, 0.5 - 1 mm ²	50	156
6205	■	Insl. solderless terminal M5, 0.5 - 1 mm ²	50	156
670	■	Insl. butt connector, 0.5 - 1 mm ²	50	165
720	■	Insl. receptacle 6.3 x 0.8 mm, 0.5 - 1 mm ²	50	161
6304	■	Insl. solderless terminal M4, 1.5 - 2.5 mm ²	50	156
6305	■	Insl. solderless terminal M5, 1.5 - 2.5 mm ²	50	156
680	■	Insl. butt connector, 1.5 - 2.5 mm ²	50	165
730	■	Insl. receptacle 6.3 x 0.8 mm, 1.5 - 2.5 mm ²	50	161
6505	■	Insl. solderless terminal M5, 4 - 6 mm ²	20	156
6506	■	Insl. solderless terminal M6, 4 - 6 mm ²	20	156
700	■	Insl. butt connector, 4 - 6 mm ²	20	165
715	■	Insl. pin terminal, 0.1 - 0.4 mm ² , 26 mm	20	158
620C4	■	Insl. solderless terminal M4, 0.5 - 1 mm ²	20	157
630C4	■	Insl. solderless terminal M4, 1.5 - 2.5 mm ²	20	157
705	■	Insl. pin terminal, 0.5 - 1 mm ² , 22 mm	20	158
710	■	Insl. pin terminal, 1.5 - 2.5 mm ² , 23 mm	20	158

SK 82 S Assortment box from plastic with insl. cable connections and crimping tool



- ▶ The exact-shaped foam inlays of the case prevent the contents slipping even with severe impacts

Item	Part No.			
Plastic assortment box with insl. cable connections and crimping tool	SK82S			
Scope of supply	Colour	Description	Quantity	Page
K82A		Crimping tool for insulated cable connections 0.5 - 6 mm ²	1	222
6204	■	Insl. solderless terminal M4, 0.5 - 1 mm ²	20	156
6205	■	Insl. solderless terminal M5, 0.5 - 1 mm ²	20	156
670	■	Insl. butt connector, 0.5 - 1 mm ²	20	165
720	■	Insl. receptacle 6.3 x 0.8 mm, 0.5 - 1 mm ²	20	161
6304	■	Insl. solderless terminal M4, 1.5 - 2.5 mm ²	20	156
680	■	Insl. butt connector, 1.5 - 2.5 mm ²	20	165
730	■	Insl. receptacle 6.3 x 0.8 mm, 1.5 - 2.5 mm ²	20	161
6305	■	Insl. solderless terminal M5, 1.5 - 2.5 mm ²	20	156



SK 30 L Steel carrying case



▶ Hammer-tone finished assortment box

Characteristics

- 4 small and 1 large additional compartments with lock

Suitable for

- For optional storage of crimping tools type K1, K4, K46 and K48

Item	Dimension mm	Weight kg	Part No.
Steel carrying case	200 x 140 x 40	1.2	SK30L

SK 32 L Steel carrying case



▶ Hammer-tone finished assortment box

Characteristics

- 8 small and 1 large additional compartments with lock

Suitable for

- For optional storage of crimping tools type K3 and K35

Item	Dimension mm	Weight kg	Part No.
Steel carrying case	285 x 155 x 45	1.3	SK32L

SK 4 L Steel carrying case



▶ Hammer-tone finished assortment box

Characteristics

- 6 small and 1 large additional compartments with lock

Suitable for

- For optional storage of crimping tools type K02, K2, K16, K25, K28 and K29

Item	Dimension mm	Weight kg	Part No.
Steel carrying case	370 x 160 x 40	1.4	SK4L

SK 43 L Steel carrying case



▶ Hammer-tone finished assortment box

Characteristics

- 8 small and 2 large additional compartments with lock

Suitable for

- For storage of crimping tool K 32 and wire stripper K 41

Item	Dimension mm	Weight kg	Part No.
Steel carrying case	370 x 210 x 40	1.9	SK43L

MK 55 Steel carrying case



▶ Hammer-tone finished assortment box

Characteristics

- 8 small and 1 large additional compartments with lock

Suitable for

- For storage of 8 pairs of dies and crimping tool K50

Item	Dimension mm	Weight kg	Part No.
Steel carrying case	245 x 130 x 37	0.7	MK55

MK 210 L Steel carrying case



▶ Hammer-tone finished assortment box

Characteristics

- 4 small and 1 large additional compartments with lock

Suitable for

- For storage of crimping tools K 10 or K 82

Item	Dimension mm	Weight kg	Part No.
Steel carrying case	250 x 155 x 40	1.0	MK210L

MK 220 L Steel carrying case



▶ Hammer-tone finished assortment box

Characteristics

- 8 small and 1 large additional compartments with lock

Suitable for

- For storage of crimping tools K 10 or K 82

Item	Dimension mm	Weight kg	Part No.
Steel carrying case	370 x 160 x 40	1.4	MK220L

MK 230 L Steel carrying case



▶ Hammer-tone finished assortment box

Characteristics

- 19 small and 1 large additional compartments with lock and handle

Suitable for

- For storage of crimping tools K 10 or K 82

Item	Dimension mm	Weight kg	Part No.
Steel carrying case	366 x 230 x 51	2.4	MK230L



SK 65 L Steel carrying case



▶ Hammer-tone finished assortment box

Characteristics

- 12 small and 1 large additional compartments with lock and handle

Suitable for

- For storage of crimping tools type K 05, K 05 BC, K 35/4

Item	Dimension mm	Weight kg	Part No.
Steel carrying case	400 x 250 x 50	2.3	SK65L

MK 18 Steel carrying case



▶ Hammer-tone finished assortment box

Characteristics

- 34 small and 1 large additional compartments with lock and handle

Suitable for

- For storage of 34 pairs of dies and crimping tool K 18

Item	Dimension mm	Weight kg	Part No.
Steel carrying case	605 x 300 x 50	4.6	MK18

MK 22 Steel carrying case

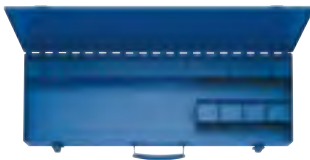

▶ Hammer-tone finished assortment box

Characteristics

- 17 small and 1 large additional compartments with lock and handle

Suitable for

- For storage of 17 pairs of dies and crimping tool K 22

Item	Dimension mm	Weight kg	Part No.
Steel carrying case	600 x 220 x 65	3.5	MK22

KKPE Plastic case



Characteristics

- With lock and handle

Suitable for

- For storing complete crimping die sets

Item	Part No.
Plastic case	KKPE
Plastic case	KKPEH25
Plastic case for crimping dies of series 13	KKPE13

MK/KP 1 Plastic case



Characteristics

- With lock and handle

Suitable for

- For storage of crimping tools KP1 and KP1L and 10 crimping heads of the Klauke Pro Series

Item	Dimension mm	Weight kg	Part No.
Plastic case	395 x 295 x 106	1.0	MKKP1

MKU Steel carrying case with wheels



▶ Hammer-tone finished assortment box

Characteristics

- With additional compartment for dies with lock and handle

Suitable for

- For storage of hydraulic crimping tools HK12/2, HK25/2 or HK45

Item	Dimension mm	Weight kg	Part No.
Steel carrying case	810 x 310 x 210	10.0	MKU

TT2 Carrying case



Suitable for

- For storing all crimping and cutting heads (excluding SDK 105, SDK 120 and PK1000)

Item	Weight kg	Part No.
Carrying bag	0.48	TT2

TT4 Carrying case



Suitable for

- For storage of cutting heads SDK 105 and SDK 120

Item	Weight kg	Part No.
Carrying bag	0.73	TT4





SYSTEMATIC ORDER - L-BOXX FROM BS SYSTEMS

We must have order, especially when on the go. L-Boxx from BS Systems is a well thought out arrangement system for safely transporting your Klauke tool and connectors no matter what. Klauke products are safely stowed in the L-Boxx - matched to your individual equipment. Keep the overview!



In brief

- ▶ Available in various sizes
- ▶ Maximum protection due to shock and impact resistant materials
- ▶ Easy to transport with practical handle on the cover and the sides
- ▶ Simple stacking of several boxes thanks to click system

▶ **Large or small?**

The L-Boxx provides the right tool every time. Select what you need from the broad range of sizes. The boxes are always shock and impact resistant and can be stacked without risk of slipping due to a click system.

- Available in various sizes
- Shock and impact resistant
- Easy to transport with practical handles on the cover and on the sides
- Safe transportation and storage due to click system



▶ **Everything practically packed**

The L-Box doesn't just stow your tools - they also assign them exactly the right storage location. Trust in our Klauke system of pre-stocked boxes for various applications.

- Pre-stocked boxes equipped to your needs
- Choice for differing areas of applications
- Everything to hand in one box

▶ **Sorted on the go**

Do you need your toolboxes on the go? With the TÜV-tested Sortimo vehicle equipment, all Klauke tools and ranges can be systematically and safely transported in L-Boxxes.

- Quickly located thanks to the Sortimo system overview
- Avoid injury by securing the boxes against accidents and braking actions
- Short searching time for efficient operations



L-BOXX 65B from plastic with standard equipment for electrical installations



- Comprehensive equipment for conductor preparation, comprising cable cutter, cable knife, crimping tool and connectors

Characteristics

- Manufactured from shock and impact resistant ABS plastic, very robust, 100 kg capacity
- Stackable using an Easy-Click system, which allows easy opening and closing

Item	Dimension mm	Part No.	
L-BOXX from plastic with standard equipment for electrical installations	442 x 357 x 117	LBOXX65B	
Scope of supply	Description	Quantity	Page
K05	Crimping tool for tubular cable lugs and connectors, standard type 6 - 50 mm ²	1	235
K100	Hand-operated cutting tool for Cu and Al cables to 14 mm dia.	1	364
KL740416	Cable knife, without blade 4 - 16 mm dia.	1	547
1R6	Tubular cable lug without inspection hole, 6 mm ² , M6, Cu tinned	25	14
1R8	Tubular cable lug without inspection hole, 6 mm ² , M8, Cu tinned	25	14
2R6	Tubular cable lug without inspection hole, 10 mm ² , M6, Cu tinned	25	14
2R8	Tubular cable lug without inspection hole, 10 mm ² , M8, Cu tinned	25	14
3R10	Tubular cable lug without inspection hole, 16 mm ² , M10, Cu tinned	25	14
4R8	Tubular cable lug without inspection hole, 25 mm ² , M8, Cu tinned	20	14
4R10	Tubular cable lug without inspection hole, 25 mm ² , M10, Cu tinned	20	14
5R8	Tubular cable lug without inspection hole, 35 mm ² , M8, Cu tinned	20	14
5R10	Tubular cable lug without inspection hole, 35 mm ² , M10, Cu tinned	20	14
6R10	Tubular cable lug without inspection hole, 50 mm ² , M10, Cu tinned	15	15
LBOXX102LFG	L-BOXX with front handle	1	



L-BOXX 50B from plastic with standard equipment for electrical installations



► Comprehensive equipment for conductor preparation, comprising cable cutter, cable knife, crimping tool and connectors

Characteristics

- Manufactured from shock and impact resistant ABS plastic, very robust, 100 kg capacity
- Stackable using an Easy-Click system, which allows easy opening and closing

Item	Dimension mm	Part No.	
L-BOXX from plastic with standard equipment for electrical installations	442 x 357 x 117	LBOXX65B	
Scope of supply	Description	Quantity	Page
K05D	Crimping tool for compression cable lugs and connectors (DIN 46235 / DIN 46267, Part 1) 6 - 50 mm ²	1	235
K100	Hand-operated cutting tool for Cu and Al cables to 14 mm dia.	1	364
KL740416	Cable knife, without blade 4 - 16 mm dia.	1	547
101R6	Compression cable lug, DIN 46235, 6 mm ² , M6, Cu tinned	25	14
101R8	Compression cable lug, 6 mm ² , M8, Cu tinned	25	14
102R6	Compression cable lug, DIN 46235, 10 mm ² , M6, Cu tinned	25	14
102R8	Compression cable lug, 10 mm ² , M8, Cu tinned	25	14
103R10	Compression cable lug, DIN 46235, 16 mm ² , M10, Cu tinned	25	14
104R8	Compression cable lug, DIN 46235, 25 mm ² , M8, Cu tinned	20	14
104R10	Compression cable lug, DIN 46235, 25 mm ² , M10, Cu tinned	20	14
105R8	Compression cable lug, DIN 46235, 35 mm ² , M8, Cu tinned	15	14
106R8	Compression cable lug, DIN 46235, 50 mm ² , M8, Cu tinned	10	14
106R10	Compression cable lug, DIN 46235, 50 mm ² , M10, Cu tinned	10	15
LBOXX102LFG	L-BOXX with front handle	1	

L-BOXX 65BCB from plastic with blue connection® - equipment



► Extensive equipment based on the blue connection® product line, including crimping tool, cutting tool and cable knife

Characteristics

- Manufactured from shock and impact resistant ABS plastic, very robust, 100 kg capacity
- Stackable using an Easy-Click system, which allows easy opening and closing

Item	Dimension mm	Part No.	
L-BOXX from plastic with blue connection® equipment	442 x 357 x 117	LBOXX65BCB	
Scope of supply	Description	Quantity	Page
K05BC	Crimping tool for tubular cable lugs and connectors, blue connection® 6 - 50 mm ²	1	234
K100	Hand-operated cutting tool for Cu and Al cables to 14 mm dia.	1	364
KL740416	Cable knife, without blade 4 - 16 mm dia.	1	547
6B6	Tubular cable lugs, blue connection®, 6 mm ² , M6, Cu	25	28
6B8	Tubular cable lugs, blue connection®, 6 mm ² , M8, Cu	25	28
10B6	Tubular cable lugs, blue connection®, 10 mm ² , M6, Cu	25	28
10B8	Tubular cable lugs, blue connection®, 10 mm ² , M8, Cu	25	28
16B10	Tubular cable lugs, blue connection®, 16 mm ² , M10, Cu	25	28
25B8	Tubular cable lugs, blue connection®, 25 mm ² , M8, Cu	20	28
25B10	Tubular cable lugs, blue connection®, 25 mm ² , M10, Cu	20	28
35B8	Tubular cable lugs, blue connection®, 35 mm ² , M8, Cu	20	28
35B10	Tubular cable lugs, blue connection®, 35 mm ² , M10, Cu	20	28
50B10	Tubular cable lugs, blue connection®, 50 mm ² , M10, Cu	20	28
LBOXX102LFG	L-BOXX with front handle	1	

L-BOXX 230 B from plastic with standard equipment for electrical installations



Item	Dimension mm	Part No.		
L-BOXX from plastic with standard equipment for electrical installations	442 x 357 x 117	LBOXX230B		
Scope of supply	Colour	Description	Quantity	Page
K432		Automatic wire stripper K43/2 0.02 - 10 mm ²	1	545
K507		Crimping tool with replaceable dies	1	243
720	■	Insl. receptacle 6.3 x 0.8 mm, 0.5 - 1 mm ²	50	161
730	■	Insl. receptacle 6.3 x 0.8 mm, 1.5 - 2.5 mm ²	50	161
820	■	Insl. tab 6.3 x 0.8 mm, 0.5 - 1 mm ²	50	164
830	■	Insl. tab 6.3 x 0.8 mm, 1.5 - 2.5 mm ²	50	164
6204	■	Insl. solderless terminal M4, 0.5 - 1 mm ²	50	156
6305	■	Insl. solderless terminal M5, 1.5 - 2.5 mm ²	50	156
6506	■	Insl. solderless terminal M6, 4 - 6 mm ²	50	156
670	■	Insl. butt connector, 0.5 - 1 mm ²	50	165
680	■	Insl. butt connector, 1.5 - 2.5 mm ²	50	165
700	■	Insl. butt connector, 4 - 6 mm ²	25	165
1652C5		Solderless terminals 10 mm ² , M5	50	78
1652C6		Solderless terminals 10 mm ² , M6	50	78
4708	■	Insl. cable end-sleeve, 0.75 mm ² , 14 mm	400	141
4718	■	Insl. cable end-sleeve, 1 mm ² , 14 mm	400	141
4728	■	Insl. cable end-sleeve, 1.5 mm ² , 14 mm	400	141
4738	■	Insl. cable end-sleeve, 2.5 mm ² , 14 mm	200	141
47410	■	Insl. cable end-sleeve, 4 mm ² , 17 mm	100	141
47512	■	Insl. cable end-sleeve, 6 mm ² , 20 mm	100	141
47612	■	Insl. cable end-sleeve, 10 mm ² , 22 mm	100	141
LBOXX102LFG		L-BOXX with front handle	1	

L-BOXX Mini from plastic with crimping tool and insl. cable end-sleeves 0.5-16 mm²



Item	Part No.			
L-BOXX from plastic with crimping tool and cable end-sleeves 0.5 - 16 mm ²	LBOXXMINIK3			
Scope of supply	Colour	Description	Quantity	Page
K3		Crimping tool for cable end-sleeves 0.5 - 16 mm ²	1	211
K118		Hand-operated cutting tool for Cu and Al cables to 12 mm dia.	1	364
4728	■	Insl. cable end-sleeve, 1.5 mm ² , 14 mm	100	141
47312	■	Insl. cable end-sleeve, 2.5 mm ² , 18 mm	100	141
47412	■	Insl. cable end-sleeve, 4 mm ² , 20 mm	50	141
47512	■	Insl. cable end-sleeve, 6 mm ² , 20 mm	50	141
47612	■	Insl. cable end-sleeve, 10 mm ² , 22 mm	30	141
LBOXXMINIL		L-BOXX "Mini"	1	

L-BOXX Mini from plastic with crimping tool and insl. cable end-sleeves 1.5 - 10 mm²



Item			Part No.	
L-BOXX from plastic with crimping tool and insl. cable end-sleeves 1.5 - 10 mm ²			LBOXXMINIK306K	
Scope of supply	Colour	Description	Quantity	Page
K306K		Crimping tool for cable end-sleeves and twin cable end-sleeves 0.08 - 16 mm ²	1	217
K118		Hand-operated cutting tool for Cu and Al cables to 12 mm dia.	1	364
4728	■	Insl. cable end-sleeve, 1.5 mm ² , 14 mm	100	141
47312	■	Insl. cable end-sleeve, 2.5 mm ² , 18 mm	100	141
47412	■	Insl. cable end-sleeve, 4 mm ² , 20 mm	50	141
47512	■	Insl. cable end-sleeve, 6 mm ² , 20 mm	50	141
47612	■	Insl. cable end-sleeve, 10 mm ² , 22 mm	30	141
LBOXXMINIL		L-BOXX "Mini"	1	

L-BOXX Mini from plastic with crimping tool and insl. cable end-sleeves 1.5 - 10 mm²



Item			Part No.	
L-BOXX from plastic with crimping tool and insl. cable end-sleeves 1.5 - 10 mm ²			LBOXXMINIK304K	
Scope of supply	Colour	Description	Quantity	Page
K304K		K 30/4 K crimping tool for cable end-sleeves 0.08 to 16 mm ² and twin cable end-sleeves 2 x 0,5 - 2 x 6 mm ²	1	217
K118		Hand-operated cutting tool for Cu and Al cables to 12 mm dia.	1	364
4728	■	Insl. cable end-sleeve, 1.5 mm ² , 14 mm	100	141
47312	■	Insl. cable end-sleeve, 2.5 mm ² , 18 mm	100	141
47412	■	Insl. cable end-sleeve, 4 mm ² , 20 mm	50	141
47512	■	Insl. cable end-sleeve, 6 mm ² , 20 mm	50	141
47612	■	Insl. cable end-sleeve, 10 mm ² , 22 mm	30	141
LBOXXMINIL		L-BOXX "Mini"	1	

L-BOXX Mini from plastic with crimping tool and insl. cable end-sleeves 1.5 - 10 mm²



Item			Part No.	
L-BOXX from plastic with crimping tool and insl. cable end-sleeves 1.5 - 10 mm ²			LBOXXMINIK3014K	
Scope of supply	Colour	Description	Quantity	Page
K3014K		Crimping tool for cable end-sleeves and twin cable end-sleeves 0.14 - 10 mm ²	1	218
K118		Hand-operated cutting tool for Cu and Al cables to 12 mm dia.	1	364
4728	■	Insl. cable end-sleeve, 1.5 mm ² , 14 mm	100	141
47312	■	Insl. cable end-sleeve, 2.5 mm ² , 18 mm	100	141
47412	■	Insl. cable end-sleeve, 4 mm ² , 20 mm	50	141
47512	■	Insl. cable end-sleeve, 6 mm ² , 20 mm	50	141
47612	■	Insl. cable end-sleeve, 10 mm ² , 22 mm	30	141
LBOXXMINIL		L-BOXX "Mini"	1	



L-BOXXes with the new battery powered tools of the NEXT GENERATION

**NEXT
GENERATION**



NEW

This is just a small extract of our range. If you need a different combination, contact us.

Bosch battery

Tool	Crimping	Cutting	Punching	Part No.
EK 35/4	6 - 150 mm ²			LBOXXEK354CFB
EK 50/5	6 - 240 mm ²			LBOXXEK505CFB
EK 50/18	6 - 185 mm ²			LBOXXEK5018CFB
EKM 60/22	6 - 300 mm ²			LBOXXEKM6022CFB
EKM 60 ID	10 - 240 mm ²			LBOXXEKM60IDCFB
ES 20		max. 20 mm dia.		LBOXXES20CFB
ES 32 F		max. 32 mm dia.		LBOXXES32FCFB
ES 32		max. 32 mm dia.		LBOXXES32CFB
EKM 60 UNV	6 - 300 mm ²	max. 25 mm dia.	round/shape	LBOXXEKM60UNVCFB
LS 50 FLEX			round/shape	LBOXXLS50FLEXCFB

Makita battery

Tool	Crimping	Cutting	Punching	Part No.
EK 35/4	6 - 150 mm ²			LBOXXEK354CFM
EK 50/5	6 - 240 mm ²			LBOXXEK505CFM
EK 50/18	6 - 185 mm ²			LBOXXEK5018CFM
EKM 60/22	6 - 300 mm ²			LBOXXEKM6022CFM
EKM 60 ID	10 - 240 mm ²			LBOXXEKM60IDCFM
ES 20		max. 20 mm dia.		LBOXXES20CFM
ES 32 F		max. 32 mm dia.		LBOXXES32FCFM
ES 32		max. 32 mm dia.		LBOXXES32CFM
EKM 60 UNV	6 - 300 mm ²	max. 25 mm dia.	round/shape	LBOXXEKM60UNVCFM
LS 50 FLEX			round/shape	LBOXXLS50FLEXCFM

Crimping & cutting

(shown is the scope of supply with Bosch battery)



Part No.	Scope of supply	LBOXX-								
		EK354	EK505	EK5018	EKM6022	EKM60ID	ES20	ES32	ES32F	EKM60UNV
RALB1EU	Bosch battery 18 V / 2.0 Ah, Li-Ion	•	•	•	•	•	•	•	•	•
LGLB1EU	Bosch charger for 18 V Li-Ion batteries	•	•	•	•	•	•	•	•	•
UA22	Adapter for crimping dies									•
LBOXX136LFG	L-BOXX (W/D/H: 442 x 357 x 151 mm)	•	•	•	•	•	•	•	•	•

Punching

(shown is the scope of supply with Bosch battery)



LBOXXLS50FLEX								
Part No.	RALB2EU	LGLB1EU	50318721	50032488	52049371	51300430	50339672	LBOXX136GL
Scope of supply	Bosch battery 18 V / 5.0 Ah, Li-Ion	Bosch charger for 18 V Li-Ion batteries	Draw stud for hydraulic operation 19 x 105 mm	Spacer, short	HSS Co5 step bit	Draw stud for punch with hydraulic operation 9.5 x 71 mm	Adapter 19 x 48 mm with internal thread 9.5 mm	L-BOXX (W/D/H: 442 x 357 x 151 mm)